

KCM-7311

4MP 3.6x with WDR 80dB



- 4 Megapixel, 3.6x,
- Color Min. Illumination 0.003 lux
- DORI (66-240 / 26.6-96.8 / 13.2-48 / 6.6-24m)
- Weatherproof (IP67), UL Listed

► Specifications

Product Profile

Product Type	Zoom Dome
Application Environment	Outdoor
Maximum Resolution	4MP
Image Sensor	Progressive Scan CMOS
Sensor Size	1/3.2 "
Effective Pixels	2592(H) X 1944(V) (5.04 MP)
Day / Night	Yes
Low Light Sensitivity	Superior
Minimum Illumination	Color: 0.003 lux at F1.4; B/W: 0.002 lux at F1.4
Mechanical IR Cut Filter	Yes
Color to B/W Switch	ISP based switch, configurable
Electronic Shutter	1/5-1/2000 second (manual mode); 1/5-1/10000 second (auto mode)
Horizontal Resolution (TV Lines)	1422 TVL
S/N Ratio	75 dB

Lens

Focal Length	Zoom, f3.3-12mm
--------------	-----------------

Aperture	F1.4-F2.9
Zoom Ratio	3.6x optical zoom
Zoom Application	Camera Installation, Auto Zoom by Event, Manual Operation
Iris	P-Iris
Focus	Auto focus
Lens Mount	Board mount
Horizontal Viewing Angle	77.2° - 22.6°
Viewing Angle Adjustment	Pan: 0°-350°, Tilt: 0°-180°, Rotation: 0°-350°

PTZ

Pan, Tilt or Zoom protocol	Visca
----------------------------	-------

Video

Compression	H.264 (Baseline), MPEG-4 SP, MJPEG
Maximum Frame Rate vs. Resolution	8 fps at 2032 x 1920 15 fps at 1920 x 1080 30 fps at 1280 x 720 30 fps at 640 x 480
Bit Rate	28Kbps - 6Mbps
Bit Rate Mode	Constant, Variable
Multi-Streaming	Simultaneous dual streams based on two configurations
Digital Noise Reduction	2D + 3D DNR
Wide Dynamic Range	Advanced WDR (80 dB)
Image Orientation	Flip, Mirror
Image Enhancement	White Balance, Brightness, Saturation, Contrast, Sharpness, Automatic gain control (AGC), Flickerless, Defogging
Privacy Mask	4 configurable regions
Text Overlay	Yes
Server-based Analytics	Object Line Counting, People Counting, Face Detection, Object Based Motion Detection, Tamper, Object Line Crossing Detection, Object Enter Area Detection, Missing Object Detection, Unattended Object Detection, Smoke Detection, Heat Map, Dwell Time, Direction Detection, Automatic License Plate Recognition, People Queue Detection, (Require PC-based or standalone IVS or ALPR Server. Contact ACTi support for recommendations on how to maximize analytical accuracy)

Audio

Audio Type	2-way, Line-in, Line-out
Audio Compression	8 kHz, 16 bit encoding, Mono, PCM, G.711

Network

Network Protocol & Service	IPv4/v6, TCP, UDP, DHCP, PPPoE, HTTP, HTTPS, DNS, DDNS, NTP, RTP, RTSP, SMTP, FTP, IGMP, ICMP, ARP, Bonjour, UPnP, ToS, SNMP, IEEE 802.1X
Ethernet Port	1 x RJ-45 connector
Security	IP address filtering, HTTPS encryption, Password protected user level, IEEE 802.1X network access control

Detection Range

Observation Range	Detection: 66m-240m Observation: 26.6m-96.8m Recognition: 13.2m-48m Identification: 6.6m-24m
-------------------	--

Event

Event Trigger	Video motion detection (3 regions), External device through digital input,
Event Response	Notify control center, Go to Zoom preset point or preset tour, Change camera settings, Command other devices, E-mail notification with snapshots, Save video or snapshot to storage, Upload video or snapshot to FTP server, Activate external device through digital output

System

Watchdog	Support
----------	---------

Integration

Unified Solution	Fully compatible with ACTi software
Software Development Kit	Yes
ONVIF Compliant	Yes, Profile S
Web Browser	IE 8.0 or newer

Interface

Audio Interface	Terminal block
Digital Input/Output	2/2
Operating Button	Reset Button

General

Power Source	DC 12V, PoE Class 3 (IEEE802.3af)
Power Consumption	12.24 W (PoE)
Weight	1050g (2.315lb)
Dimensions	(Ø x H): 151.69mm x 114.9mm (5.97" x 4.52")
Environmental Casing	Weatherproof (IP67), Vandal proof
Mount Type	Surface, Gang Box, Flush, Pendant, Converter for NPT Standard Mounts, Wall Mount, Pole Mount, Corner Mount
Starting Temperature	-10°C ~ 50°C (14°F ~ 122°F) within 30 minutes
Operating Temperature	-30°C ~ 50°C (-22°F ~ 122°F)
Operating Humidity	10% - 85% RH, non-condensing
Approvals	CE, FCC, IP67, UL Listed (UL 60950-1)
Real-time Clock (RTC)	Yes
Warranty	3 Year(s). For extended warranty offering, see http://www.acti.com/support/warranty

► Photo Indication

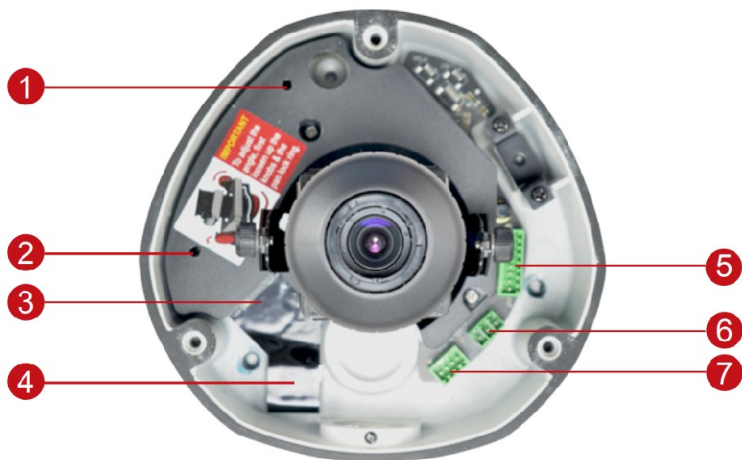

- 1 Reset Button
- 2 Power Button
- 3 Ethernet Port
- 4 MicroSDHC Card Slot
- 5 Digital Input/Output
- 6 DC 12V Power Input
- 7 Audio Input / Output



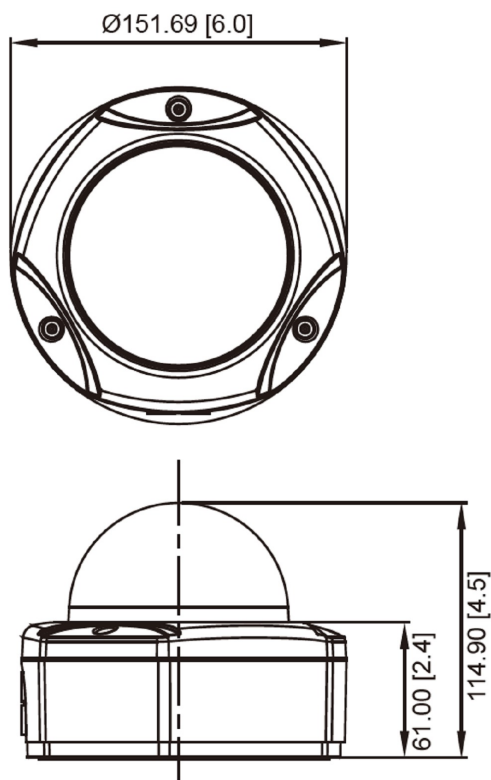









► Dimension Diagram



Unit: mm [inch]



► Related Products

Mounting Accessories - Camera Mount

PMAX-0102		Straight Tube
PMAX-0103		Straight Tube with Bracket
PMAX-0104		Extension Tube
PMAX-0302		Gooseneck with Bracket
PMAX-0303		Gooseneck
PMAX-0305		Heavy Duty Wall Mount
PMAX-0354		Heavy Duty Wall Mount for A711, A713
PMAX-0402		Corner Mount
PMAX-0503		Pole Mount (for PMA-0102, PMA-0312, PMA-0313, PMA-0314, PMA-0702, PMA-1106, PMA-1107), supports 5.25" to 8.5" Poles
PMAX-0505		Pole Mount (for B4x, B41x, E44, E45, E46, E48, E44A, E45A, E46A, E41x, I4x, PMA-0312, PMA-0313, PMA-0314, PMA-0330), supports 2" to 3" Poles
PMAX-0702		Junction Box for PTZ and Dome Cameras
PMAX-0804		Gang Box Converter for Outdoor Domes, supports Two-Gang Boxes
PMAX-1003		Flush Mount Kit (for D6x, D7x, D8x, E61~E67, E7x [except E78], E81~E88)

Note: Some mounting accessories may need additional accessories for installation. Please check www.acti.com/mountingselector for more information.

Network & Storage Peripherals - Data Switch

PPSW-0105		PLANET GS-4210-8P2C 8-Port Gigabit 802.3at Managed PoE Switch (PoE Budget 120W)
PPSW-1101		PLANET GS-4210-24PL4C 24-Port Gigabit 802.3at Managed PoE Switch (PoE Budget 440W)
PPSW-3100		PLANET FGSW-1816HPS 16-Port 802.3at PoE Switch (PoE Budget 220W)

Extenders - PoE Extender

PPEX-0100



Veracity OUTREACH Max Power over Ethernet (PoE) Extender

Extenders - PoE over Coaxial Extender Kit

PPOC-0100



Planet LRP-101C-KIT Power over Coax Adapter Kit

Other Accessories - Camera Part

R707-70002



Rubber base for KCM-7311

R707-70003



Washer for KCM-7311