

# Z910

## 2MP f2.8mm Outdoor Fixed Dome with IR LED 50m, WDR 120dB



- 2 Megapixel, f2.8mm, Fixed Dome
- IR LED 50m, Superior WDR (120 dB)
- Color Min. Illumination 0.003 lux
- DORI (42.0 / 16.8 / 8.4 / 4.2m)
- Weatherproof (IP68), Vandal proof (IK10), UL Listed

### ► Specifications

#### Product Profile

Product Type	Fixed Dome
Application Environment	Outdoor
Maximum Resolution	2MP
Image Sensor	Progressive Scan CMOS
Sensor Size	1/2.7 "
Day / Night	Yes
Low Light Sensitivity	Extreme
Minimum Illumination	Color: 0.003 lux at F2.0 (AGC on); B/W: 0 lux (IR LED on)
Mechanical IR Cut Filter	Yes
IR LED	Adaptive IR LED (850 nm)
IR Working Distance	50m
Electronic Shutter	1-1/100000 second (manual mode); 1-1/100000 second (auto mode)
S/N Ratio	75 dB

#### Lens

Focal Length	Fixed focal, f2.8mm
--------------	---------------------

Aperture	F2.0
Iris	Fixed iris
Focus	Fixed focus
Lens Mount	Board mount
Horizontal Viewing Angle	108.6°
Vertical Viewing Angle	62.7°
Viewing Angle Adjustment	Pan: 3°-360°, Tilt: 0°-68°, Rotation: 0°-360°

**Video**

Compression	H.265 Adaptive Stream, H.264 Adaptive Stream, MJPEG
Maximum Frame Rate vs. Resolution	30 fps at 1920 x 1080 30 fps at 1280 x 720 30 fps at 720 x 576 30 fps at 640 x 360
Multi-Streaming	Simultaneous dual streams
Digital Noise Reduction	2D + 3D DNR
Wide Dynamic Range	Superior WDR (120 dB)
Image Orientation	Flip, Mirror, Rotation (Corridor mode)
Image Enhancement	White Balance, Backlight compensation (BLC), Brightness, Contrast, Sharpness, Automatic gain control (AGC), Defogging
Privacy Mask	4 configurable regions
Text Overlay	Yes
Built-in Analytics	People Detection, Vehicle Detection, Tampering Detection, Object Based Motion Detection, Object Line Crossing Detection, Intrusion Detection (Forbidden Area Detection)

**Audio**

Audio Type	1-way, Built-in Microphone
Audio Compression	G.711

**Network**

Network Protocol & Service	IPv4, TCP, UDP, DHCP, HTTP, HTTPS, DNS, DDNS, NTP, RTP, RTSP, RTCP, RTMP, SMTP, FTP, IGMP, ICMP, ARP, UPnP, SNMP, SSL, QoS, TLS 1.2
Ethernet Port	1 x Ethernet (10/100 Base-T), RJ-45 pigtail connector
Security	IP address filtering, HTTPS encryption, Password protected user level

**Detection Range**

Observation Range	Detection: 42.0m Observation: 16.8m Recognition: 8.4m Identification: 4.2m
-------------------	--

**Event**

Event Trigger	Video motion detection (4 regions), Sound detection, Intelligent event detection
Event Response	E-mail notification with snapshots, Upload snapshot to FTP server, Save video or snapshot to storage

**Integration**

Edge Recording	Support (integration with NVR by ONVIF Profile G)
----------------	---

ONVIF Compliant	Yes, Profile S, Profile G, Profile T
Web Browser	IE 11, Google Chrome, Microsoft Edge, Firefox

**Interface**

Operating Button	No
------------------	----

**General**

Power Source	DC 12V, PoE (IEEE802.3af)
Power Consumption	5 W (PoE)
Weight	357.5g (0.79lb)
Dimensions	(Ø x H): 109mm x 83mm (4.3" x 3.3")
Environmental Casing	Weatherproof (IP68), Vandal proof (IK10)
Corrosion Protection	Optional for project request. Chassis corrosion resistance at the seashore approximately 3 years.
Operating Temperature	-40°C ~ 60°C (-40°F ~ 140°F)
Operating Humidity	10% - 95% RH, non-condensing
Surge Protection	4KV
Approvals	CE Class B, FCC Class B, IP68, IK10, UL Listed
Color	White
Real-time Clock (RTC)	No
Warranty	2 Year(s). For extended warranty offering, see <a href="http://www.acti.com/support/warranty">http://www.acti.com/support/warranty</a>

\* Edge Recording function is integrated with NVR 3 Corporate / NVR 3 Business / INR / GNR series.



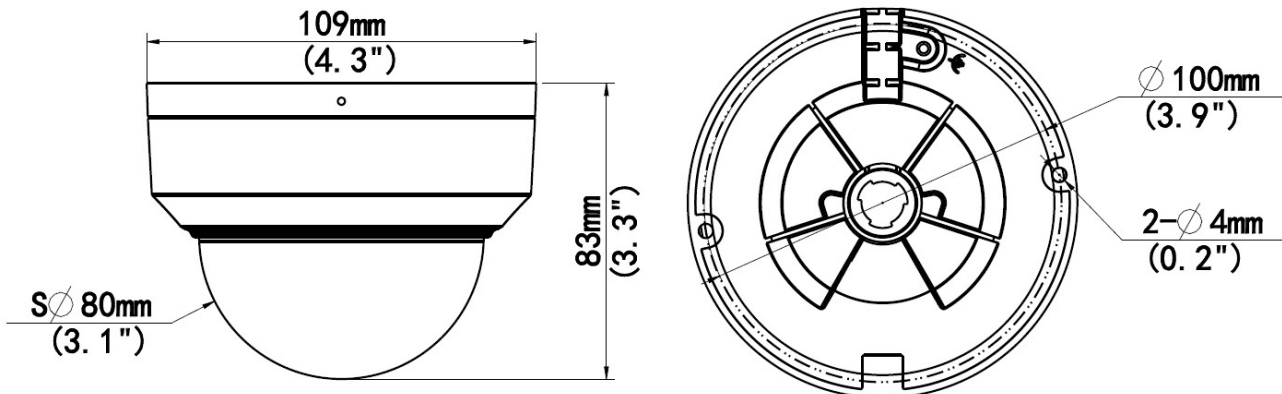









► **Dimension Diagram**



Unit: mm [inch]

## ► Related Products

### Mounting Accessories - Camera Mount

PMAX-0122		Straight Tube (for A71, A88, A9x,)
PMAX-0123		Extension Tube (for A71, A88, A9x,)
PMAX-0128		Pendant Mount (for Z5x, Z724, Z85, Z86, Z87, Z810, Z972, Q550)
PMAX-0318		Wall Mount (for Z91, Z97, Z98, Z710, Z714, Z715, A71, A76, A77)
PMAX-0349		Wall Mount with Built-in Junction Box (for Z71, Z72)
PMAX-0365		Wall Mount with Built-in Junction Box (for Y7x, Z5x, Z7x, Z91x)
PMAX-0409		Corner Mount (for A7x, Z714, Z724, Z8x, Z9x, Z972, Q550, K3x, K5x, K7x)
PMAX-0506		Pole Mount (for A31, A4x, E78, E9x, E9xx), supports 2" to 3" Poles
PMAX-0532		Pole Mount (for Z5x, Z724, Z8x, Z9x, Z972, A7X, Q550), supports 2.6" to 5" Poles
PMAX-0712		Junction box (for Z91, Z92, Z94, Z95, Z97, Z98, Z714, Z77)
PMAX-0816		Converter Ring, 1.0" NPT for Third-Party Mounting Accessories, White
PMAX-0820		Gang Box Converter (for A71, A74, Z91, Z94, Z95), supports 4" Round and 4" Octagon Boxes
PMAX-1402		Mount Kit (for Z91, Z97, Z98, Z710, Z714, Z715, A71, A76, A77)

**Note:** Some mounting accessories may need additional accessories for installation. Please check [www.acti.com/mountingselector](http://www.acti.com/mountingselector) for more information.

### Dome Covers - Smoked Dome Cover

PDCX-1119		
-----------	---	--

### Power Supply Accessories - Power Adapter

PPBX-0013		Power Adapter AC 100~240V (EU), for A3x, A4x, A88, A9x, Z31, Z8x, Z9x
-----------	---	---

PPBX-0014



Power Adapter AC 100~240V (UK), for A3x, A4x, A88, A9x, Z31, Z8x, Z9x

PPBX-0026



Power Adapter AC 100~240V (US), for A3x, A4x, A7x, A88, A9x, Z3x, Z4x, Z7x, Z8x, Z9x

### Power Supply Accessories - PoE Injector

PPOE-0107



High PoE Injector IEEE 802.3at compliant, AC 100~240V, with universal connectors (for A416, A418, B913, B923, B934, Q450, Q75, VMGB-60X, Z37, Z71, Z952)