

Z954

8MP Deep Learning AI 25x Outdoor PTZ with IR LED 200m, WDR 145dB



- 8 Megapixel, 25x, PTZ
- Deep Learning AI
- 1/1.8" Sensor, IR LED 200m, Extreme WDR (145 dB)
- Color Min. Illumination 0.003 lux
- PTZ Auto Tracking, 360° endless
- Counting
- DORI (143.1-3116.3 / 57.2-1246.5 / 28.6-623.3 / 14.3-311.6m)
- Weatherproof (IP66), Vandal proof (IK10), UL Listed

► Specifications

Product Profile

Product Type	PTZ
Application Environment	Outdoor
Maximum Resolution	8MP
Image Sensor	Progressive Scan CMOS
Sensor Size	1/1.8 "
Effective Pixels	3864(H) X 2180(V) (8.42 MP)
Day / Night	Yes
Low Light Sensitivity	Extreme
Minimum Illumination	Color: 0.003 lux at F1.5 (AGC on); B/W: 0 lux (IR LED on)
Mechanical IR Cut Filter	Yes
IR Sensitivity Range	700-1100nm
IR LED	Adaptive IR LED x 10 (850 nm)
IR Working Distance	200m
Color to B/W Switch	ISP based switch, configurable
Electronic Shutter	1-1/100000 second (manual mode); 1-1/100000 second (auto mode)

Horizontal Resolution (TV Lines)	2800 TVL
S/N Ratio	75 dB

Lens

Focal Length	Zoom, f6.0-150mm
Aperture	F1.5-F3.4
Zoom Ratio	25x optical zoom, 16x digital zoom
Iris	Auto iris
Focus	Auto focus
Lens Mount	Board mount
Horizontal Viewing Angle	60.5° - 3.1°
Vertical Viewing Angle	36.3° - 1.8°

PTZ

Manual Panning / Tilting Speed	0.1° - 200°/second, 0.1° - 200°/second
Preset Panning / Tilting Speed	300°/second, 240°/second
Panning Range	360° endless
Tilting Range	-15°~90° (with E-flip)
PTZ Control	Remote manual control, Speed Control, Drag to Pan and Tilt, 1024 preset points, 16 preset tours
Absolute Position	Yes

Video

Compression	H.265 Adaptive Stream, H.264 (High profile), MJPEG
Maximum Frame Rate vs. Resolution	30 fps at 3840 x 2160 30 fps at 3072 x 2048 30 fps at 2560 x 1440 30 fps at 2688 x 1520 30 fps at 1920 x 1080 30 fps at 1280 x 720 30 fps at 720 x 576 30 fps at 640 x 360
Multi-Streaming	Simultaneous triple streams
Digital Noise Reduction	2D + 3D DNR
Wide Dynamic Range	Extreme WDR (145 dB)
Image Orientation	Flip, Mirror
Image Enhancement	White Balance, Backlight compensation (BLC), Defogging
Privacy Mask	24 configurable regions
Text Overlay	Yes
Built-in Analytics	People Flow Counting, People Density Counting, Face Detection, PTZ Auto Tracking, Tampering Detection, Intrusion Detection (Forbidden Area Detection), Object Line Crossing Detection, Object Enter Area Detection, Object Exit Area Detection, People Line Crossing Detection, People Enter Area Detection, People Exit Area Detection

Analytics

Deep Learning AI	2.0
------------------	-----

Audio

Audio Type	2-way, Line-in, Line-out
Audio Compression	G.711 u-law, G.711 A-law

Network

Network Protocol & Service	IPv4, TCP, UDP, DHCP, PPPoE, HTTP, HTTPS, DNS, DDNS, NTP, RTP, RTSP, RTCP, RTMP, SMTP, FTP, IGMP, ICMP, ARP, UPnP, QoS, SSL/TLS, IEEE 802.1X
Ethernet Port	1 x Ethernet (10/100 Base-T), RJ-45 pigtail connector
Maximum User Connections	32
Security	IP address filtering, HTTPS encryption, Password protected user level, IEEE 802.1X network access control

Detection Range

Observation Range	Detection: 143.1m-3116.3m Observation: 57.2m-1246.5m Recognition: 28.6m-623.3m Identification: 14.3m-311.6m
-------------------	---

Event

Event Trigger	Video motion detection, Intelligent event detection, Sound detection, External device through digital input
Event Response	E-mail notification with snapshots, Upload snapshot to FTP server, Save video or snapshot to storage

System

System Log	Support
------------	---------

Integration

ONVIF Compliant	Yes, Profile S, Profile G, Profile T
Web Browser	IE 11, Google Chrome, Microsoft Edge, Firefox
SD Card Backup and Recovery	Automatically back up the video recordings from the memory card of camera to Server via ONVIF (Profile G) integration with recovering lost videos after network connection recovery.

Interface

Serial Port	1 x RS-485
Audio Interface	1/1, 3.5mm Phone Jack
Analog Video Output	1 x BNC connector
Digital Input/Output	2/1
Operating Button	Reset Button

General

Power Source	AC 24V, DC 24V, PoE Class 5 (IEEE802.3bt)
Power Consumption	58 W (PoE)
Weight	5610g (12.36lb)
Dimensions	(Ø x H): 227mm x 384mm (8.9" x 15.1")
Environmental Casing	Weatherproof (IP66), Vandal proof metal casing (IK10)

Corrosion Protection	Optional for project request. Chassis corrosion resistance at the seashore approximately 3 years.
Bundled Accessories	Power Adapter
Mount Type	Wall Mount, Pole Mount, Pendant, Corner Mount
Starting Temperature	-40°C ~ 70°C (-40°F ~ 158°F)
Operating Temperature	-40°C ~ 70°C (-40°F ~ 158°F)
Surge Protection	6KV
Approvals	CE Class A, FCC Class A, IP66, IK10 (metal casing), UL Listed
Real-time Clock (RTC)	Yes
Warranty	2 Year(s). For extended warranty offering, see http://www.acti.com/support/warranty

▶ Photo Indication



- 1 Serial Port
- 2 AC24V Power Input
- 3 Digital Input / Output
- 4 Ethernet Port
- 5 Analog Video Output
- 6 Audio Input / Output
- 7 Reset Button



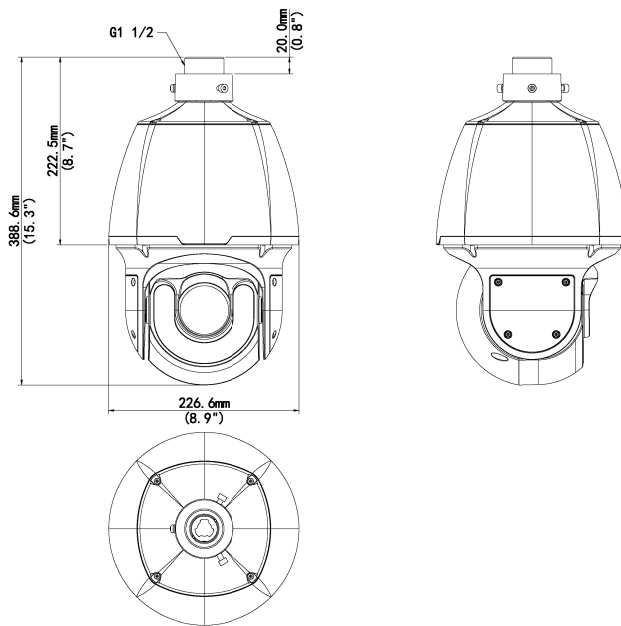















▶ Dimension Diagram



Unit: mm [inch]

▶ Related Products

Mounting Accessories - Camera Mount

PMAX-0104		Extension Tube
PMAX-0115		Pendant Mount (for A950, A951, A952, A956, Z950, Z952)
PMAX-0116		Straight Tube, 200 mm (for Z950)
PMAX-0117		Straight Tube (for Z950, Z952)
PMAX-0126		Straight Tube with Bracket and Converter Ring (for Q75)
PMAX-0322		Wall mount (for Z950, Z952)
PMAX-0343		Gooseneck with Bracket with Converter Ring (for Q75)
PMAX-0344		Gooseneck with Converter Ring (for Q75)
PMAX-0346		Heavy Duty Wall Mount with Converter Ring (for Q75, A950, A951, A952, A956)
PMAX-0358		Parapet Wall Mount (for Z95X, Q84).
PMAX-0402		Corner Mount
PMAX-0404		Corner Mount (for Z950, Z952)
PMAX-0503		Pole Mount (for PMAX-0102, PMAX-0312, PMAX-0313, PMAX-0314, PMAX-0702, PMAX-1106, PMAX-1107), supports 5.25" to 8.5" Poles
PMAX-0513		Pole Mount (for Z950, Z952)
PMAX-0702		Junction Box for PTZ and Dome Cameras
PMAX-0711		Junction box (for Z950, Z952)
PMAX-0807		Gangbox Converter (for PMAX-0102, PMAX-0312, PMAX-0313, PMAX-0314, PMAX-0321), supports Two-Gang Boxes
PMAX-1403		Ceiling Mount (for Z950, Z952)

Note: Some mounting accessories may need additional accessories for installation. Please check www.acti.com/mountingselector for more information.

Power Supply Accessories - PoE Injector

PPOE-0201



High PoE Injector Single-port, IEEE 802.3bt Type 4, Gbps, 90W 4-Pairs POE indoor midspans, AC 100~240V, with universal connectors (for Z954, Q83)

PPOE-0202



High PoE injector 90Watt 10/100/1000M/Multi Gigabit PoE Injector (for A952, A956, Z953, Z954, Q83, Q84)

Audio Devices - Microphone

PMIC-0100



Active Microphone Omnidirectional for all Cameras with Line-in Audio