

A313

4MP Deep Learning AI f2.8mm Fixed Bullet with IR LED 65m, WDR 150dB



- 4 Megapixel, f2.8mm, Fixed Bullet
- Deep Learning AI
- IR LED 65m, Extreme WDR (150 dB)
- Color Min. Illumination 0.003 lux
- DORI (67 / 26 / 13 / 6m)
- Weatherproof (IP68), Vandal proof (IK10), UL Listed
- Taiwan IoT Cybersecurity Certification

► Specifications

Product Profile

Product Type	Fixed Bullet
Application Environment	Outdoor
Maximum Resolution	4MP
Image Sensor	Progressive Scan CMOS
Sensor Size	1/2.7 "
Effective Pixels	2688(H) X 1520(V) (4 MP)
Day / Night	Yes
Low Light Sensitivity	Extreme
Minimum Illumination	Color: 0.003 lux; B/W: 0 lux (IR LED on)
Mechanical IR Cut Filter	Yes
IR LED	IR LED x 3 (850 nm)
IR Working Distance	65m
Electronic Shutter	1/5-1/100000 second (auto mode)
S/N Ratio	75 dB

Lens	
Focal Length	Fixed focal, f2.8mm
Aperture	F1.6
Iris	Fixed iris
Focus	Fixed focus
Lens Mount	Board mount
Horizontal Viewing Angle	99°
Vertical Viewing Angle	56°
Viewing Angle Adjustment	Pan: 0°-360°, Tilt: 0°-90°, Rotation: 0°-360°

Video	
Compression	H.265 Adaptive Stream (equivalent to Zip or Smart Stream or H.265+), H.265, H.264 Adaptive Stream (equivalent to Zip or Smart Stream or H.264+), H.264, MJPEG
Maximum Frame Rate vs. Resolution	30 fps at 2688 x 1520 30 fps at 2560 x 1440 30 fps at 1920 x 1080 30 fps at 1280 x 960 30 fps at 1280 x 720 30 fps at 640 x 480 30 fps at 352 x 240
Bit Rate Mode	Constant, Variable
Multi-Streaming	Simultaneous quad streams
Digital Noise Reduction	2D + 3D DNR
Wide Dynamic Range	Extreme WDR (150 dB)
Image Orientation	Flip, Mirror, Rotation (Corridor mode) (90°, 180°, 270°)
Image Enhancement	White Balance, Brightness, Contrast, Sharpness, Saturation, Backlight compensation (BLC), Strong Light Suppression, Automatic exposure, Automatic gain control (AGC)
Privacy Mask	4 configurable regions
Text Overlay	Yes
On-Screen Graphics (Picture Overlay)	Yes
Built-in Analytics	Deep Learning : Face Detection, People Detection, Vehicle Detection, Tampering Detection, Object Based Motion Detection, Object Line Crossing Detection, Object Enter Area Detection, People Line Crossing Detection, People Enter Area Detection, Vehicle Line Crossing Detection, Vehicle Enter Area Detection

Analytics	
Deep Learning AI	1.0

Network	
Network Protocol & Service	IPv4, IPv6, TCP, UDP, DHCP, PPPoE, HTTP, HTTPS, DNS, DDNS, NTP, RTP, RTSP, RTCP, SRTP, LLDP, SMTP, FTP, SFTP, IGMP, ICMP, ARP, UPnP, Bonjour, QoS, TLS 1.2, TLS 1.3, SNMP, IEEE 802.1X, SMB/CIFS (SAMBA)
Ethernet Port	1 x Ethernet (10/100 Base-T), RJ-45 pigtail connector
Security	IP address filtering, HTTPS encryption, TLS v1.2, TLS v1.3 encrypted communication, SRTP encrypted video streaming, Password protected user level, Anonymous login, IEEE 802.1X network access control, Standard IoT Security (anti-hacking, anti-malware)

Detection Range

Observation Range	Detection: 67m Observation: 26m Recognition: 13m Identification: 6m
-------------------	---

Event

Event Trigger	Video motion detection (4 polygonal regions with up to 10 vertices), Intelligent event detection, Sound detection, Video streams loss, System log buffer overrun, Remove system log, Logon events (Login Failure, Login Success, Block an Account)
Event Response	Notify control center, Change camera settings, Command other devices, E-mail notification with snapshots, Push notification to mobile device, Save video to storage, Save video to NAS storage via NFS or SMB/CIFS (SAMBA), Upload video to NVR server, Upload video or snapshot to FTP server

System

System Monitor	CPU loading, memory usage and network statistics via API
System Log	Support
Watchdog	Support

Integration

Unified Solution	Fully compatible with ACTi software
GPS Position	Manual setting
Edge Recording	Support (integration with NVR by ONVIF Profile G or proprietary protocol)(*2)
ONVIF Compliant	Profile S, Profile G, Profile T, Profile M
Web Browser	IE 11, Google Chrome*, Microsoft Edge*, Apple Safari*
Auto Firmware Upgrade	Yes

Interface

Operating Button	Reset Button
------------------	--------------

Installation

Installation Tool	Built-in Pixel Counter
-------------------	------------------------

General

Power Source	DC 12V, PoE Class 3 (IEEE802.3af)
Power Consumption	6 W (DC), 7 W (PoE)
Weight	490g (1.1lb)
Dimensions	(W x H x D): 71mm x 71mm x 170mm (2.79" x 2.79" x 6.69")
Environmental Casing	Weatherproof (IP68), Vandal proof metal casing (IK10)
Corrosion Protection	Optional for project request. Chassis corrosion resistance at the seashore approximately 3 years.
Mount Type	Pole Mount
Operating Temperature	-40°C ~ 60°C (-40°F ~ 140°F)
Operating Humidity	10% - 95% RH, non-condensing
Approvals	CE Class B, FCC Class B, IP68, IK10 (metal casing), UL Listed, Taiwan IoT Cybersecurity Certification (TAICS Level 1, CNS-16120 Level 1)
Color	White

Real-time Clock (RTC)

Yes

Warranty

3 Year(s). For extended warranty offering, see <http://www.acti.com/support/warranty>

* cross-browser compatibility: Not available for H.265 video decoding *2 Edge Recording function is integrated with NVR 3 Corporate / NVR 3 Business / INR / GNR series.

► Photo Indication



- 1 DC 12V Power Input
- 2 Ethernet Port
- 3 Memory Card Slot
- 4 Reset Button

► Dimension Diagram

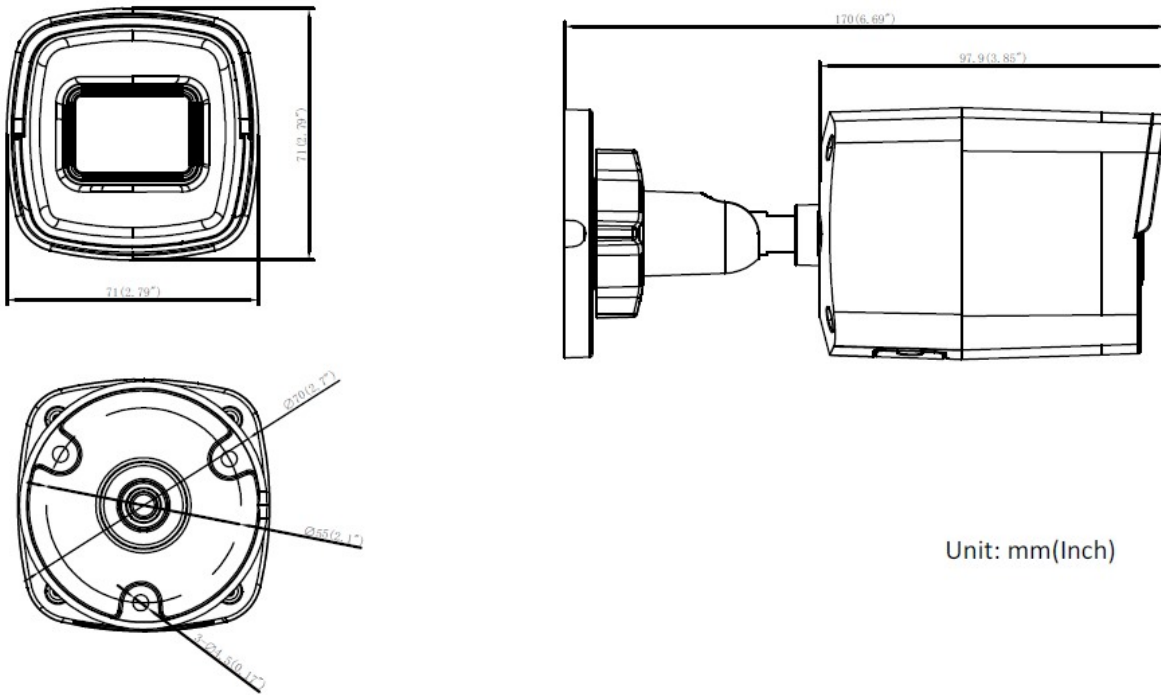

Unit: mm(Inch)

Unit: mm [inch]

► Related Products

Mounting Accessories - Camera Mount

PMAX-0533  Pole mount for A310, A311.

PMAX-0726  Junction box for A310, A311

Note: Some mounting accessories may need additional accessories for installation. Please check www.acti.com/mountingselector for more information.

Power Supply Accessories - Power Adapter

PPBX-0013  Power Adapter AC 100~240V (EU), for A3x, A4x, A88, A9x, Z31, Z8x, Z9x

PPBX-0014  Power Adapter AC 100~240V (UK), for A3x, A4x, A88, A9x, Z31, Z8x, Z9x

PPBX-0026  Power Adapter AC 100~240V (US), for A3x, A4x, A7x, A88, A9x, Z3x, Z4x, Z7x, Z8x, Z9x

Power Supply Accessories - PoE Injector

PPOE-0107  High PoE Injector IEEE 802.3at compliant, AC 100~240V, with universal connectors (for A416, A418, B913, B923, B934, Q450, Q75, VMGB-60X, Z37, Z71, Z952)

Network & Storage Peripherals - Data Switch

PPSW-0102  PLANET FGSD-1011HP 8-Port 802.3at PoE Switch (PoE Budget 120W)

PPSW-0108  8-Port Gigabit 802.3at Managed PoE Switch (PoE Budget 120W)

PPSW-0109  8-Port 802.3at Smart Managed PoE Switch (PoE Budget 120W)

PPSW-1101  PLANET GS-4210-24PL4C 24-Port Gigabit 802.3at Managed PoE Switch (PoE Budget 440W)

PPSW-1107  24-port 10/100/1000Mbps PoE, Smart Managed Gigabit Ethernet PoE Switch

PPSW-2105  4-Port 802.3at Smart Managed Gigabit PoE Switch

PPSW-3101  16-Port Gigabit 802.3at Managed PoE Switch (PoE Budget 240W)

PPSW-3103  16-Port 802.3at Smart Managed PoE Switch (PoE Budget 250W)

PPSW-3104  16-Port 802.3at Smart Managed PoE Switch (PoE Budget 250W)

PPSW-3402  16-Port 10/100/1000T 802.3bt PoE + 8-Port 10/100/1000T + 4-Port 10G SFP+ Managed Ethernet Switch

PPSW-4205  24-Port 10/100/1000T 802.3at PoE + 2-Port 100/1000X SFP Managed Switch (PoE Budget 300W)

Illuminators - IR LED Illuminator

PLED-0210

