

# Z315

## 5MP Deep Learning AI LightGuard f2.8mm Fixed Bullet with IR LED 50m, WDR 120dB



- 5 Megapixel, f2.8mm, Fixed Bullet
- Deep Learning AI, LightGuard
- IR LED 50m, Superior WDR (120 dB)
- Color Min. Illumination 0.003 lux
- Smart Motion Detection
- Weatherproof (IP68), Vandal proof (IK10), UL Listed

### ► Specifications

#### Product Profile

Product Type	Fixed Bullet
Application Environment	Outdoor
Maximum Resolution	5MP
Image Sensor	Progressive Scan CMOS
Sensor Size	1/2.7 "
Day / Night	Yes
Low Light Sensitivity	Extreme
LightGuard	Yes
Minimum Illumination	Color: 0.003 lux at F1.6 (AGC on); B/W: 0 lux (IR LED on)
Mechanical IR Cut Filter	Yes
IR LED	Adaptive IR LED (850 nm)
IR Working Distance	50m
Electronic Shutter	1-1/100000 second (manual mode); 1-1/100000 second (auto mode)
S/N Ratio	75 dB

<b>Lens</b>	
Focal Length	Fixed focal, f2.8mm
Aperture	F1.6
Iris	Fixed iris
Horizontal Viewing Angle	112.9°
Vertical Viewing Angle	59.1°
Viewing Angle Adjustment	Pan: 0°-360°, Tilt: 0°-90°, Rotation: 0°-360°

<b>Video</b>	
Compression	H.265 Adaptive Stream, H.264 Adaptive Stream, MJPEG
Maximum Frame Rate vs. Resolution	25 fps at 2880 x 1620 25 fps at 2560 x 1440 30 fps at 2304 x 1296 30 fps at 1920 x 1080 30 fps at 1280 x 720 30 fps at 720 x 576 30 fps at 640 x 360
Bit Rate	128Kbps - 16Mbps
Multi-Streaming	Simultaneous dual streams
Digital Noise Reduction	2D + 3D DNR
Wide Dynamic Range	Superior WDR (120 dB)
Image Orientation	Flip, Mirror, Rotation (Corridor mode)(±90°, 180°)
Image Enhancement	White Balance, Defogging
Privacy Mask	4 configurable regions
Text Overlay	Yes
Built-in Analytics	Smart Motion Detection (People Detection, Vehicle Detection), People Detection, Vehicle Detection, Object Line Crossing Detection, People Intrusion Detection, Tampering Detection

<b>Analytics</b>	
Deep Learning AI	1.0

<b>Audio</b>	
Audio Type	1-way, Built-in Microphone
Audio Compression	G.711

<b>Network</b>	
Network Protocol & Service	IPv4/v6, TCP, UDP, DHCP, PPPoE, HTTP, HTTPS, DNS, DDNS, NTP, RTP, RTSP, RTCP, SMTP, FTP, IGMP, ICMP, ARP, UPnP, SNMP, QoS, SSL, IEEE 802.1X
Ethernet Port	1 x Ethernet (10/100 Base-T), RJ-45 pigtail connector

<b>Event</b>	
Event Trigger	Video motion detection, Sound detection, Intelligent event detection
Event Response	E-mail notification with snapshots, Upload snapshot to FTP server, Save video or snapshot to storage

<b>Integration</b>	
ONVIF Compliant	Yes, Profile S, Profile G, Profile T
Web Browser	IE 11, Google Chrome, Microsoft Edge, Firefox

**Interface**

Operating Button	No
------------------	----

**General**

Power Source	DC 12V, PoE (IEEE802.3af)
Power Consumption	6 W (PoE)
Weight	430g (0.95lb)
Dimensions	(L x W x H): 190mm x 73mm x 71mm (7.5" x 2.9" x 2.8")
Environmental Casing	Weatherproof (IP68), Vandal proof metal casing (IK10)
Corrosion Protection	Optional for project request. Chassis corrosion resistance at the seashore approximately 3 years.
Mount Type	Pole Mount
Operating Temperature	-30°C ~ 60°C (-22°F ~ 140°F)
Approvals	CE, FCC Class B, IP68, IK10 (metal casing), UL Listed, CE Class A, FCC Class A, IP68, IK10, UL Listed, RoHS
Color	White
Real-time Clock (RTC)	No
Warranty	2 Year(s). For extended warranty offering, see <a href="http://www.acti.com/support/warranty">http://www.acti.com/support/warranty</a>

### ► Photo Indication



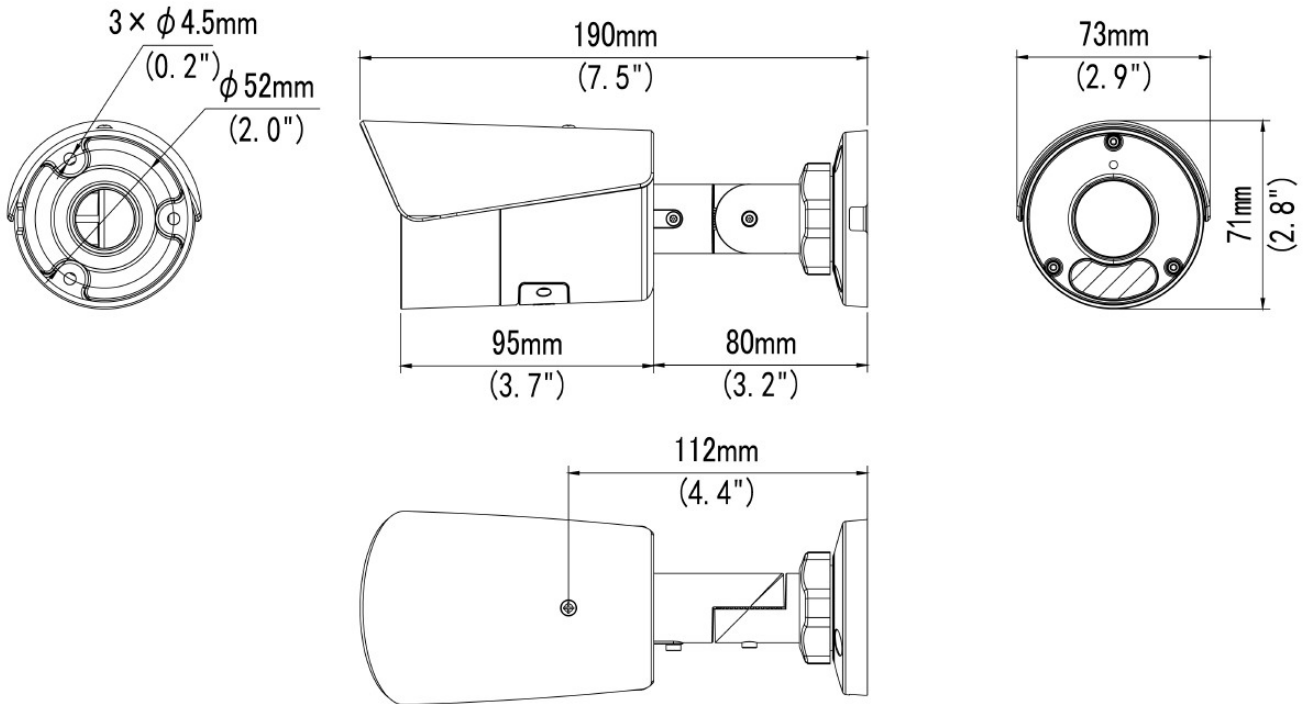

### ► Dimension Diagram



Unit: mm [inch]

## ▶ Related Products

### Mounting Accessories - Camera Mount

PMAX-0538		Pole Mount (for Z3x, Z4x, Z5x, Z724, Z8x, Z9x, Z972, A7x, Q550, K3x, K5x, K7x) , supports 2.64" to 5" Poles
PMAX-0729		Junction Box (for Z39, Z310, Z48, Z49)

**Note:** Some mounting accessories may need additional accessories for installation. Please check [www.acti.com/mountingselector](http://www.acti.com/mountingselector) for more information.









### Power Supply Accessories - Power Adapter



PPBX-0013		Power Adapter AC 100~240V (EU), for A3x, A4x, A88, A9x, Z31, Z8x, Z9x
PPBX-0014		Power Adapter AC 100~240V (UK), for A3x, A4x, A88, A9x, Z31, Z8x, Z9x
PPBX-0026		Power Adapter AC 100~240V (US), for A3x, A4x, A7x, A88, A9x, Z3x, Z4x, Z7x, Z8x, Z9x
PPBX-0034		Power Adapter AC 100~240V (US) for A3x, A4x, A7x, A88, A9x, Z3x, Z4x, Z7x, Z8x, Z9x, Q550

### Power Supply Accessories - PoE Injector

PPOE-0107		High PoE Injector IEEE 802.3at compliant, AC 100~240V, with universal connectors (for A416, A418, B913, B923, B934, Q450, Q75, VMGB-60X, Z37, Z71, Z952)
-----------	---	--

### Network & Storage Peripherals - Data Switch

PPSW-0102		PLANET FGSD-1011HP 8-Port 802.3at PoE Switch (PoE Budget 120W)
PPSW-0108		8-Port Gigabit 802.3at Managed PoE Switch (PoE Budget 120W)
PPSW-0109		8-Port 802.3at Smart Managed PoE Switch (PoE Budget 120W)
PPSW-1101		PLANET GS-4210-24PL4C 24-Port Gigabit 802.3at Managed PoE Switch (PoE Budget 440W)
PPSW-1107		24-port 10/100/1000Mbps PoE, Smart Managed Gigabit Ethernet PoE Switch
PPSW-2105		4-Port 802.3at Smart Managed Gigabit PoE Switch
PPSW-3101		16-Port Gigabit 802.3at Managed PoE Switch (PoE Budget 240W)
PPSW-3103		16-Port 802.3at Smart Managed PoE Switch (PoE Budget 250W)

PPSW-3104		16-Port 802.3at Smart Managed PoE Switch (PoE Budget 250W)
PPSW-3402		16-Port 10/100/1000T 802.3bt PoE + 8-Port 10/100/1000T + 4-Port 10G SFP+ Managed Ethernet Switch
PPSW-4205		24-Port 10/100/1000T 802.3at PoE + 2-Port 100/1000X SFP Managed Switch (PoE Budget 300W)