

# A713

## 5MP f1.1mm Outdoor Hemispheric Dome with IR LED 20m, WDR 135dB



- 5 Megapixel, f1.1mm, Hemispheric Dome
- IR LED 20m, Extreme WDR (135 dB)
- Frame Rate 60fps
- DORI (26.1 / 10.5 / 5.2 / 2.6m)
- Weatherproof (IP66), Vandal proof (IK10)
- Built-in TPM 2.0 security

### ► Specifications

#### Product Profile

Product Type	Hemispheric Dome
Application Environment	Outdoor
Maximum Resolution	5MP
Image Sensor	Progressive Scan CMOS
Sensor Size	1/2.7 "
Effective Pixels	2592(H) X 1944(V) (5.04 MP)
Day / Night	Yes
Low Light Sensitivity	Superior
Minimum Illumination	Color: 0.01 lux at F2.4; B/W: 0 lux (IR LED on)
Mechanical IR Cut Filter	Yes
IR Sensitivity Range	700-1100nm
IR LED	Adaptive IR LED
IR Working Distance	20m
Color to B/W Switch	ISP based switch, configurable
Electronic Shutter	1-1/10000 second (manual mode); 1-1/10000 second (auto mode)

Horizontal Resolution (TV Lines)	1800 TVL
S/N Ratio	75 dB

**Lens**

Focal Length	Fixed focal, f1.1mm
Aperture	F2.4
Iris	Fixed iris
Focus	Fixed focus
Lens Mount	Board mount
Horizontal Viewing Angle	197° (overview area)
Vertical Viewing Angle	197° (Fisheye View)

**Video**

Compression	H.265 Adaptive Stream, H.264 Adaptive Stream, MJPEG
Maximum Frame Rate vs. Resolution	(Camera-side Dewarped Views) (Camera-side Dewarped Views) (Overview) 30 fps at 1920 x 1920 30 fps at 1920 x 1080 30 fps at 1600 x 1200 30 fps at 1408 x 1408 27 fps at 960 x 960 27 fps at 960 x 720 27 fps at 960 x 544 (ePTZ View) 30 fps at 1920 x 1920 30 fps at 1920 x 1080 30 fps at 1600 x 1200 30 fps at 1408 x 1408 30 fps at 960 x 960 30 fps at 960 x 720 30 fps at 960 x 544 30 fps at 480 x 360 (360° Dewarped View) 30 fps at 1920 x 1920 30 fps at 1920 x 1080 30 fps at 1600 x 1200 60 fps at 1408 x 1408 60 fps at 960 x 960 27 fps at 960 x 720 27 fps at 960 x 544 (Quad Mode) 30 fps at 1920 x 1920 30 fps at 1920 x 1080 30 fps at 1600 x 1200 30 fps at 1408 x 1408 30 fps at 960 x 960 30 fps at 960 x 720 30 fps at 960 x 544 (180° Dewarped View) 30 fps at 1920 x 1080 30 fps at 1600 x 1200 30 fps at 960 x 720 30 fps at 960 x 544 (Multiple View) 30 fps at 1920 x 1920 30 fps at 1920 x 1080 30 fps at 1600 x 1200 30 fps at 1408 x 1408 30 fps at 960 x 960 30 fps at 960 x 720 30 fps at 960 x 544 (Original Fisheye Stream) 30 fps at 2688 x 1944 30 fps at 2592 x 1944 30 fps at 2688 x 1512 60 fps at 1920 x 1080 60 fps at 1280 x 1024 60 fps at 1280 x 720 60 fps at 800 x 600 60 fps at 720 x 480 60 fps at 640 x 480 60 fps at 352 x 240 60 fps at 320 x 240
View Mode	Fisheye View Dewarped View 270-degree Corner View Multiple View ePTZ View
Bit Rate	128Kbps - 12Mbps
Bit Rate Mode	Constant, Variable
Multi-Streaming	Simultaneous quad streams based on configurations of video resolution, compression format, and frame rate
Digital Noise Reduction	2D + 3D DNR
Wide Dynamic Range	Extreme WDR (135 dB)
Image Orientation	Flip, Mirror
Image Enhancement	White Balance, Brightness, Contrast, Sharpness, Saturation, Automatic gain control (AGC), Backlight compensation (BLC)
Privacy Mask	Yes, 5 configurable regions
Text Overlay	Yes
Built-in Analytics	Tampering Detection

**Audio**

Audio Type	2-way, Line-in, Line-out
Audio Compression	PCM, G.711, G.726, AAC

## Network

Network Protocol & Service	IPv4/v6, TCP, UDP, PPPoE, HTTP, HTTPS, DDNS, NTP, RTP, RTSP, SMTP, FTP, ICMP, ARP, UPnP, QoS, SNMP, IEEE 802.1X
Ethernet Port	1 x Ethernet (10/100 Base-T), RJ-45 pigtail connector
Security	IP address filtering, HTTPS encryption, Password protected user level, IEEE 802.1X network access control, Support Trusted Platform Module 2.0 (TPM 2.0)

## Detection Range

Observation Range	Detection: 26.1m Recognition: 5.2m Identification: 2.6m Observation: 10.5m
-------------------	--

## Event

Event Trigger	Video motion detection, Tampering detection, External device through digital input, Sound detection
Event Response	E-mail notification with snapshots, Save video to storage, Upload snapshot to FTP server, Activate external device through digital output

## System

System Log	Support
Watchdog	Support

## Integration

Unified Solution	Fully compatible with ACTi software
Edge Recording	Support (integration with NVR by ONVIF Profile G)
ONVIF Compliant	Profile S, Profile G, Profile T, Profile M
Web Browser	Microsoft Edge(IE mode), Microsoft Edge, Google Chrome, Firefox

## Interface

Audio Interface	1/1, Cable with 3.5mm Phone Jack
Digital Input/Output	1/1 (Terminal block)
Operating Button	Reset Button

## General

Power Source	DC 12V, PoE Class 0 (IEEE802.3af)
Power Consumption	12.95 W (PoE)
Weight	557.5g (1.23lb)
Dimensions	(Ø x H): 130mm x 57.8mm (5.11" x 2.28")
Environmental Casing	Weatherproof (IP66), Vandal proof (IK10)
Corrosion Protection	Optional for project request. Chassis corrosion resistance at the seashore approximately 3 years.
Mount Type	Wall Mount, Pole Mount, Pendant, Corner Mount, Gang Box
Heater	Yes
Operating Temperature	-30°C ~55°C (-22°F ~ 131°F) heater on
Operating Humidity	10% - 90% RH, non-condensing
Approvals	CE Class A, FCC Class A, IP66, IK10

## Hemispheric Dome

Real-time Clock (RTC)	Yes
Warranty	3 Year(s). For extended warranty offering, see <a href="http://www.acti.com/support/warranty">http://www.acti.com/support/warranty</a>

► Photo Indication

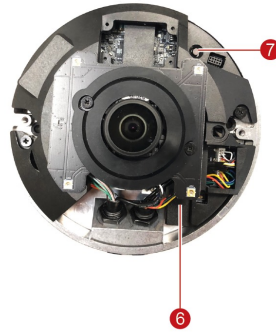

- 1 DC 12V Power Input
- 2 Ethernet Port
- 3 Audio Input
- 4 Digital Input / Output
- 5 Audio Output
- 6 Memory Card Slot
- 7 Reset Button



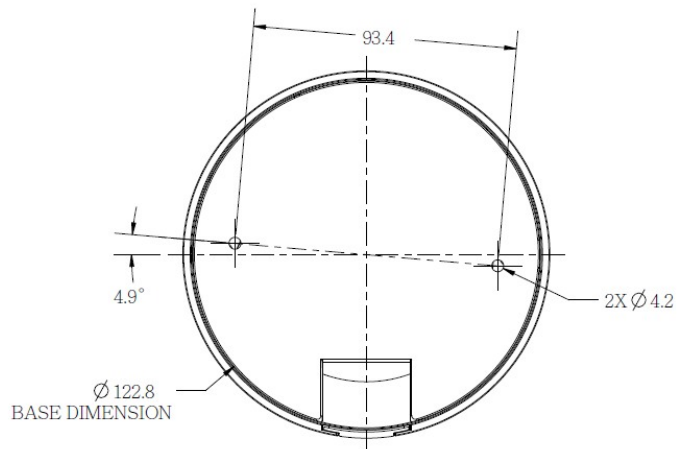
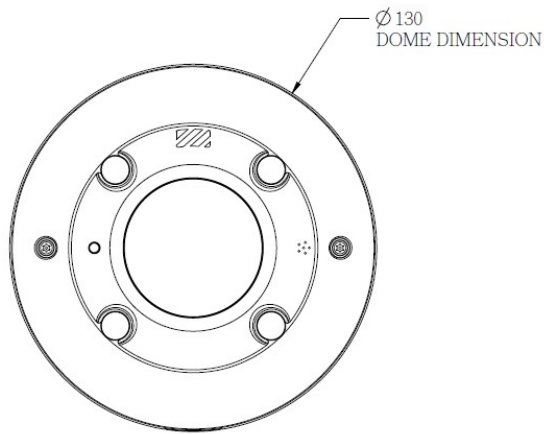
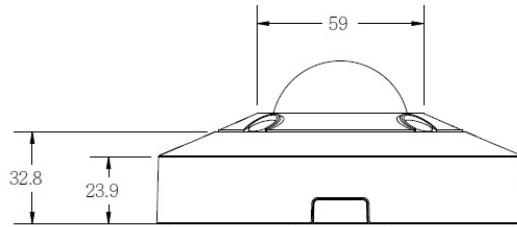
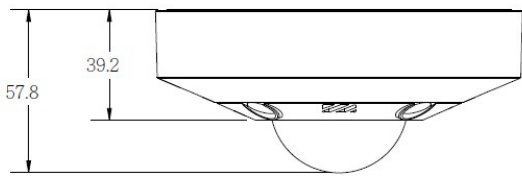









► Dimension Diagram



Unit: mm [inch]

## ▶ Related Products

### Mounting Accessories - Camera Mount

PMAX-0102		Straight Tube
PMAX-0103		Straight Tube with Bracket
PMAX-0130		Mount Kit (for A711, A713)
PMAX-0302		Gooseneck with Bracket
PMAX-0303		Gooseneck
PMAX-0354		Heavy Duty Wall Mount for A711, A713
PMAX-0355		10-Degree Tilted Wall Mount (for A711, A713)
PMAX-0356		35-Degree Tilted Wall Mount (for A711, A713)
PMAX-0402		Corner Mount
PMAX-0503		Pole Mount (for PMA-0102, PMA-0312, PMA-0313, PMA-0314, PMA-0702, PMA-1106, PMA-1107), supports 5.25" to 8.5" Poles
PMAX-0702		Junction Box for PTZ and Dome Cameras
PMAX-0822		Gang Box Converter (for A711, A713)
PMAX-1033		Flush Mount (for A711, A713)

**Note:** Some mounting accessories may need additional accessories for installation. Please check [www.acti.com/mountingselector](http://www.acti.com/mountingselector) for more information.

### Dome Covers - Transparent Dome Cover

R701-90004		Dome Cover Housing with Transparent Dome Cover (for A711, A713)
------------	---	---

### Power Supply Accessories - Power Adapter

PPBX-0011		Power Adapter AC 100~240V, with universal connectors for all DC12V powered devices
-----------	---	--

### Power Supply Accessories - PoE Injector

PPOE-0107



High PoE Injector IEEE 802.3at compliant, AC 100~240V, with universal connectors (for A416, A418, B913, B923, B934, Q450, Q75, VMGB-60X, Z37, Z71, Z952)

### Network & Storage Peripherals - Memory Card

PMMC-0400



SanDisk 128GB MicroSDXC Class 10 Memory Card (SDSQQNR-128G-GN6IA)

PMMC-0500



Kingston 256GB MicroSDXC Class 10 UHS-1 Memory Card (SDCS2/256Gb)