

# A425

## 2MP 4.3x Zoom Bullet with IR LED 55m, WDR 150dB



- 2 Megapixel, 4.3x, Zoom Bullet
- IR LED 55m, Extreme WDR (150 dB)
- Color Min. Illumination 0.002 lux
- Frame Rate 120fps, Frame Rate 60fps
- DORI (38.6-165.5 / 15.6-66.7 / 7.7-33.1 / 3.9-16.6m)
- Weatherproof (IP68), Vandal proof (IK10)

## ► Specifications

### Product Profile

Product Type	Zoom Bullet
Product Application	Face, People and Car Detection
Application Environment	Outdoor
Maximum Resolution	2MP
Image Sensor	Progressive Scan CMOS
Sensor Size	1/2.7 "
Effective Pixels	1945(H) X 1097(V) (2.13 MP)
Day / Night	Yes
Low Light Sensitivity	Extreme
Minimum Illumination	Color: 0.002 lux (30 IRE); B/W: 0 lux (IR LED on)
Mechanical IR Cut Filter	Yes
IR LED	Adaptive IR LED
IR Working Distance	55m
Electronic Shutter	1/5-1/64000 second (manual mode); 1/5-1/64000 second (auto mode)
Horizontal Resolution (TV Lines)	1000 TVL

S/N Ratio	75 dB
-----------	-------

## Lens

Focal Length	Zoom, f2.8-12mm
Aperture	F1.8-F3.3
Zoom Ratio	4.3x optical zoom
Zoom Application	Camera Installation
Iris	Adaptive iris
Focus	Auto focus
Lens Mount	Board mount
Horizontal Viewing Angle	106.6° - 34.6°
Vertical Viewing Angle	54.4° - 19.5°

## Video

Compression	H.265 Adaptive Stream, H.264 (Main profile), MJPEG
Maximum Frame Rate vs. Resolution	120 fps at 1920 x 1080 (High Frame Mode) 60 fps at 1920 x 1080 (High Frame Mode) 30 fps at 1920 x 1080 30 fps at 1280 x 960 120 fps at 1280 x 720 (High Frame Mode) 60 fps at 1280 x 720 (High Frame Mode) 30 fps at 1280 x 720 30 fps at 800 x 600 30 fps at 720 x 480 30 fps at 640 x 480 30 fps at 480 x 360 30 fps at 360 x 270
High Frame Mode	Support
Bit Rate Mode	Constant, Variable
Multi-Streaming	Simultaneous triple streams based on configurations of video resolution, compression format, and frame rate
Digital Noise Reduction	2D + 3D DNR
Wide Dynamic Range	Extreme WDR (150 dB)
Image Orientation	Flip, Mirror, Rotation (Corridor mode) (90°, 180°, 270°)
Image Enhancement	White Balance, Brightness, Contrast, Saturation, Sharpness, Backlight compensation (BLC), Strong Light Suppression, Digital Image Stabilizer (DIS, EIS)
Privacy Mask	4 configurable regions
Text Overlay	Yes
On-Screen Graphics (Picture Overlay)	Yes
Built-in Analytics	Deep Learning : Face Detection, People Detection, Vehicle Detection, Tampering Detection, People Line Crossing Detection, People Enter Area Detection, People Exit Area Detection, People Loitering Detection

## Audio

Audio Type	2-way, Mic-in, Line-in, Line-out
Audio Compression	8 kHz, Mono, G.711

## Network

Network Protocol & Service	IPv4/v6, TCP, UDP, DHCP, PPPoE, HTTP, HTTPS, DNS, DDNS, NTP, RTP, RTSP, RTCP, SMTP, FTP, IGMP, ICMP, ARP, Bonjour, UPnP, QoS, SNMP, IEEE 802.1X
Ethernet Port	1 x Ethernet (10/100 Base-T), RJ-45 pigtail connector

Security	IP address filtering, HTTPS encryption, Password protected user level, Anonymous login, IEEE 802.1X network access control
----------	--

## Detection Range

Observation Range	Detection: 38.6m-165.5m Observation: 15.6m-66.7m Recognition: 7.7m-33.1m Identification: 3.9m-16.6m
-------------------	---

## Event

Event Trigger	Video motion detection (3 regions), External device through digital input, Sound detection, Intelligent event detection, Video streams loss
Event Response	Notify control center, Change camera settings, Command other devices, E-mail notification with snapshots, Play the audio file, Push notification to mobile device, Save video to storage, Upload video to NVR server, Upload video or snapshot to FTP server, Activate external device through digital output

## System

System Monitor	CPU loading, memory usage and network statistics via API
Watchdog	Support

## Integration

Unified Solution	Fully compatible with ACTi software
GPS Position	Manual setting
Edge Recording	Support (integration with NVR by ONVIF Profile G or proprietary protocol)*
ONVIF Compliant	Profile S, Profile G, Profile Q, Profile T, Profile M
Web Browser	IE 11, Google Chrome, Microsoft Edge, Apple Safari
Auto Firmware Upgrade	Yes

## Interface

Audio Interface	Cable with 3.5mm Phone Jack
Digital Input/Output	1/1 (Terminal block)
Operating Button	Reset Button

## General

Power Source	DC 12V, PoE Class 3 (IEEE802.3af)
Power Consumption	12.95 W (PoE)
Weight	1240g (2.73lb)
Dimensions	(W x H x D): 94mm x 86mm x 291.1mm (3.7" x 3.38" x 11.46")
Environmental Casing	Weatherproof (IP68), Vandal proof metal casing (IK10)
Corrosion Protection	Optional for project request. Chassis corrosion resistance at the seashore approximately 3 years.
Bundled Accessories	Integrated bracket
Mount Type	Integrated Bracket, Wall Mount, Ceiling Bracket, Pole Mount
Operating Temperature	-30°C ~ 50°C (-22°F ~ 122°F)
Operating Humidity	10% - 85% RH, non-condensing
Approvals	CE Class A, FCC Class A, IP68, IK10 (metal casing)

Color	White
Real-time Clock (RTC)	Yes
Warranty	3 Year(s). For extended warranty offering, see <a href="http://www.acti.com/support/warranty">http://www.acti.com/support/warranty</a>

\* Edge Recording function is integrated with NVR 3 Corporate / NVR 3 Business / INR / GNR series.

► Photo Indication



- ① Audio Output
- ② DC 12V Power Input
- ③ Reset Button
- ④ Audio Input
- ⑤ Ethernet Port
- ⑥ Digital Input / Output



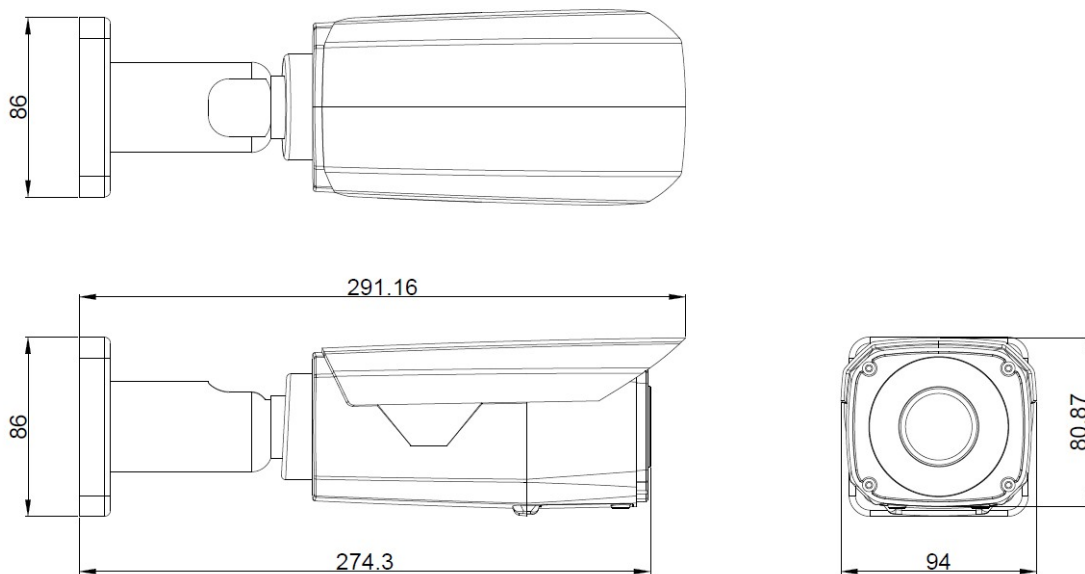

► Dimension Diagram



Unit: mm [inch]

## ► Related Products

### Mounting Accessories - Camera Mount

PMAX-0512		Pole Mount (for E39, PMAX-0706), supports 3.25" to 7.0" Poles
PMAX-0517		Pole Mount (for A44, A45, A46, A48, A413), supports 3.25" to 7.0" Poles
PMAX-0518		Pole Mount (for A44, A45, A46, A48, A413), supports 2" to 3" Poles
PMAX-0524		Pole Mount (for A46, A421, A422, A423, A425, VMGB-359), supports 2.64" to 5" Poles
PMAX-0706		Junction Box (for A3x, A4x, E39, E41x, PMAX-0805)

**Note:** Some mounting accessories may need additional accessories for installation. Please check [www.acti.com/mountingselector](http://www.acti.com/mountingselector) for more information.







### Power Supply Accessories - Power Adapter





PPBX-0013		Power Adapter AC 100~240V (EU), for A3x, A4x, A88, A9x, Z31, Z8x, Z9x
PPBX-0014		Power Adapter AC 100~240V (UK), for A3x, A4x, A88, A9x, Z31, Z8x, Z9x
PPBX-0026		Power Adapter AC 100~240V (US), for A3x, A4x, A7x, A88, A9x, Z3x, Z4x, Z7x, Z8x, Z9x

### Power Supply Accessories - PoE Injector



PPOE-0107		High PoE Injector IEEE 802.3at compliant, AC 100~240V, with universal connectors (for A416, A418, B913, B923, B934, Q450, Q75, VMGB-60X, Z37, Z71, Z952)
-----------	---	--

### Network & Storage Peripherals - Data Switch

PPSW-0102		PLANET FGSD-1011HP 8-Port 802.3at PoE Switch (PoE Budget 120W)
PPSW-0108		8-Port Gigabit 802.3at Managed PoE Switch (PoE Budget 120W)
PPSW-0109		8-Port 802.3at Smart Managed PoE Switch (PoE Budget 120W)
PPSW-1101		PLANET GS-4210-24PL4C 24-Port Gigabit 802.3at Managed PoE Switch (PoE Budget 440W)
PPSW-1107		24-port 10/100/1000Mbps PoE, Smart Managed Gigabit Ethernet PoE Switch
PPSW-2105		4-Port 802.3at Smart Managed Gigabit PoE Switch

PPSW-3101		16-Port Gigabit 802.3at Managed PoE Switch (PoE Budget 240W)
PPSW-3103		16-Port 802.3at Smart Managed PoE Switch (PoE Budget 250W)
PPSW-3104		16-Port 802.3at Smart Managed PoE Switch (PoE Budget 250W)
PPSW-3402		16-Port 10/100/1000T 802.3bt PoE + 8-Port 10/100/1000T + 4-Port 10G SFP+ Managed Ethernet Switch
PPSW-4205		24-Port 10/100/1000T 802.3at PoE + 2-Port 100/1000X SFP Managed Switch (PoE Budget 300W)

## Audio Devices - Microphone

PMIC-0100		Active Microphone Omnidirectional for all Cameras with Line-in Audio
PMIC-0200		Passive Microphone Omnidirectional for all Cameras with Mic-in Audio using 3.5mm Phone Jack

## Illuminators - IR LED Illuminator

PLED-0210	
-----------	---