

Z714

8MP Deep Learning AI LightGuard f2.8mm Outdoor Fixed Dome with IR LED 40m, WDR 130dB



- 8 Megapixel, f2.8mm, Fixed Dome
- Deep Learning AI, LightGuard
- IR LED 40m, Extreme WDR (130 dB)
- Color Min. Illumination 0.005 lux
- Smart Motion Detection
- Weatherproof (IP68), Vandal proof (IK10), UL Listed

► Specifications

Product Profile

Product Type	Fixed Dome
Application Environment	Outdoor
Maximum Resolution	8MP
Image Sensor	Progressive Scan CMOS
Sensor Size	1/2.7 "
Day / Night	Yes
Low Light Sensitivity	Superior
LightGuard	Yes
Minimum Illumination	Color: 0.005 lux at F1.6 (AGC on); B/W: 0 (IR LED on)
Mechanical IR Cut Filter	Yes
IR LED	Adaptive IR LED x 1 (850 nm)
IR Working Distance	40m
Electronic Shutter	1-1/100000 second (manual mode); 1-1/100000 second (auto mode)
S/N Ratio	75 dB

Lens

Focal Length	Fixed focal, f2.8mm
Aperture	F1.6
Iris	Fixed iris
Focus	Fixed focus
Horizontal Viewing Angle	99°
Vertical Viewing Angle	55.3°
Viewing Angle Adjustment	Pan: 8°-360°, Tilt: 0°-68°, Rotation: 10°-360°

Video

Compression	H.265 Adaptive Stream, H.264 Adaptive Stream, MJPEG
Maximum Frame Rate vs. Resolution	20 fps at 3840 x 2160 30 fps at 3072 x 1728 30 fps at 2560 x 1440 30 fps at 1920 x 1080 30 fps at 1280 x 720 30 fps at 720 x 576 30 fps at 640 x 360 30 fps at 704 x 288 30 fps at 352 x 288
Bit Rate	128Kbps - 16Mbps
Multi-Streaming	Simultaneous dual streams
Digital Noise Reduction	2D + 3D DNR
Wide Dynamic Range	Extreme WDR (130 dB)
Image Orientation	Flip, Mirror, Rotation (Corridor mode)(±90°, 180°)
Image Enhancement	White Balance, Backlight compensation (BLC), Strong Light Suppression, Brightness, Contrast, Saturation, Sharpness, Automatic gain control (AGC), Defogging
Privacy Mask	4 configurable regions
Text Overlay	Yes
Built-in Analytics	Smart Motion Detection (People Detection, Vehicle Detection), People Detection, Vehicle Detection, Object Line Crossing Detection, People Intrusion Detection, Tampering Detection

Analytics

Deep Learning AI	1.0
------------------	-----

Audio

Audio Type	1-way, Built-in Microphone
Audio Compression	G.711

Network

Network Protocol & Service	IPv4, TCP, UDP, DHCP, HTTP, HTTPS, DNS, DDNS, NTP, RTP, RTSP, RTCP, SMTP, FTP, IGMP, ICMP, ARP, UPnP, SNMP, SSL, TLS 1.2
Ethernet Port	1 x Ethernet (10/100 Base-T), RJ-45 pigtail connector
Security	IP address filtering, HTTPS encryption, Password protected user level

Event

Event Trigger	Video motion detection (4 regions), Sound detection, Tampering detection,
Event Response	E-mail notification with snapshots, Upload snapshot to FTP server, Save video or snapshot to storage

System

System Log	Support
------------	---------

Integration

Edge Recording	Support (integration with NVR by ONVIF Profile G)
ONVIF Compliant	Yes, Profile S, Profile G, Profile T
Web Browser	IE 11, Google Chrome, Microsoft Edge, Firefox

Interface

Operating Button	Reset Button
------------------	--------------

General

Power Source	DC 12V, PoE Class 3 (IEEE802.3af)
Power Consumption	4.5 W (PoE)
Dimensions	(Ø x H): 109mm x 83mm (4.3" x 3.3")
Environmental Casing	Weatherproof (IP68), Vandal proof (IK10)
Corrosion Protection	Optional for project request. Chassis corrosion resistance at the seashore approximately 3 years.
Operating Temperature	-30°C ~ 60°C (-22°F ~ 140°F)
Operating Humidity	≤95% RH, non-condensing
Approvals	CE Class B, FCC Class B, IP68, IK10, UL Listed
Color	White
Real-time Clock (RTC)	No
Warranty	2 Year(s). For extended warranty offering, see http://www.acti.com/support/warranty

► Photo Indication



- 1 DC 12V Power Input
- 2 Reset Button
- 3 Ethernet Port



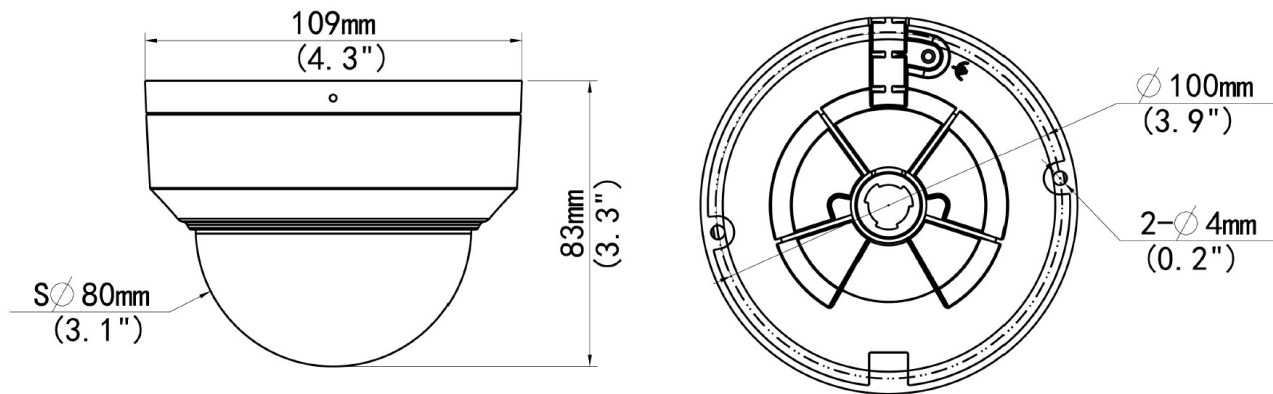









► Dimension Diagram



Unit: mm [inch]

► Related Products

Mounting Accessories - Camera Mount

PMAX-0111		Straight Tube (for D5x, D9x, E5x, E9x, E9xx/M)
PMAX-0112		Extension Tube (for D5x, D9x, E5x, E9x, E9xx/M)
PMAX-0122		Straight Tube (for A71, A88, A9x,)
PMAX-0123		Extension Tube (for A71, A88, A9x,)
PMAX-0128		Pendant Mount (for Z5x, Z724, Z85, Z86, Z87, Z810, Z972, Q550)
PMAX-0318		Wall Mount (for Z91, Z97, Z98, Z710, Z714, Z715, A71, A76, A77)
PMAX-0409		Corner Mount (for A7x, Z714, Z724, Z8x, Z9x, Z972, Q550, K3x, K5x, K7x)
PMAX-0506		Pole Mount (for A31, A4x, E78, E9x, E9xx), supports 2" to 3" Poles
PMAX-0532		Pole Mount (for Z5x, Z724, Z8x, Z9x, Z972, A7X, Q550), supports 2.6" to 5" Poles
PMAX-0712		Junction box (for Z91, Z92, Z94, Z95, Z97, Z98, Z714, Z77)
PMAX-0816		Converter Ring, 1.0" NPT for Third-Party Mounting Accessories, White
PMAX-0820		Gang Box Converter (for A71, A74, Z91, Z94, Z95), supports 4" Round and 4" Octagon Boxes
PMAX-1402		Mount Kit (for Z91, Z97, Z98, Z710, Z714, Z715, A71, A76, A77)

Note: Some mounting accessories may need additional accessories for installation. Please check www.acti.com/mountingselector for more information.

Power Supply Accessories - Power Adapter

PPBX-0013		Power Adapter AC 100~240V (EU), for A3x, A4x, A88, A9x, Z31, Z8x, Z9x
PPBX-0014		Power Adapter AC 100~240V (UK), for A3x, A4x, A88, A9x, Z31, Z8x, Z9x
PPBX-0026		Power Adapter AC 100~240V (US), for A3x, A4x, A7x, A88, A9x, Z3x, Z4x, Z7x, Z8x, Z9x

Power Supply Accessories - PoE Injector

PPOE-0107



High PoE Injector IEEE 802.3at compliant, AC 100~240V, with universal connectors (for A416, A418, B913, B923, B934, Q450, Q75, VMGB-60X, Z37, Z71, Z952)