

VMGB-359

4MP f6.2mm Thermal Bullet with IR LED 40m, White LED 40m, WDR 120dB



- 4 Megapixel, f6.2mm, Thermal Bullet
- IR LED 40m, Superior WDR (120 dB)
- White LED 40m
- Weatherproof (IP68), Vandal proof (IK10)
- Overheating Detection, Fire Detection, Thermal Surveillance
- NETD <40mK
- Fire detection up to 62m

► Specifications

Product Profile

Product Type	Thermal Bullet
Product Application	Overheating Detection, Fire Detection, Thermal Surveillance
Application Environment	Outdoor
Maximum Resolution	4MP
Description	Thermal network Bullet camera with 4MP H.265 optical module, for behavior analysis functions as Line crossing, Intrusion and area enter and exit that are for perimeter defense purpose.
Image Sensor	Progressive Scan CMOS + Thermal sensor
Sensor Size	Optical: 1/2.7"
Effective Pixels	Thermal: 160(H) X 120(V) Optical: 2688(H) X 1520(V)
Spectral Range	8-14 μ m
Thermal Sensitivity	NETD <40mK at F1.1
Spatial Resolution	2.74 mrad
Day / Night	Yes
Low Light Sensitivity	Superior
Minimum Illumination	Color: 0.017 lux at F2.25 (AGC on); B/W: 0.003 lux at F2.25 (AGC on)
Mechanical IR Cut Filter	Yes

IR LED	Adaptive IR LED
IR Working Distance	40m
White LED	Yes
White LED Working Distance	40m
Electronic Shutter	1-1/100000 second (auto mode)
S/N Ratio	75 dB

Lens

Number of Lenses	2 Lenses
Focal Length	Fixed focal, f6.2mm (Thermal camera) Fixed focal, f8.0mm (Visual camera)
Focus	Fixed focus
Horizontal Viewing Angle	(Thermal camera) 25.0° (Visual camera) 39.42°
Vertical Viewing Angle	(Thermal camera) 18.7° (Visual camera) 22.14°

Video

Compression	H.265 Adaptive Stream, H.264, MJPEG
Maximum Frame Rate vs. Resolution	(Visual camera) 30 fps at 2688 x 1520 30 fps at 1920 x 1080 30 fps at 1280 x 720 30 fps at 704 x 480 (Thermal camera) 25 fps at 1280 x 720 25 fps at 704 x 576 25 fps at 640 x 480 25 fps at 352 x 288 25 fps at 320 x 240
Multi-Streaming	Simultaneous dual streams
Digital Noise Reduction	3D DNR
Wide Dynamic Range	Superior WDR (120 dB)
Built-in Analytics	People Detection, Vehicle Detection, Object Line Crossing Detection, Object Enter Area Detection, Object Exit Area Detection, People Line Crossing Detection, People Enter Area Detection, People Exit Area Detection, People Exit Area Detection, Vehicle Line Crossing Detection, Vehicle Enter Area Detection, Vehicle Exit Area Detection, Intrusion Detection (Forbidden Area Detection), Temperature Detection, Smoking Detection, Sun-reflection Filter, Fire Detection (Temperature-based with threshold setup)

Audio

Audio Type	2-way, Mic-in, Stereo Line-in, Built-in Speaker, Line-out
Audio Compression	G.711, G.722.1, G.726, PCM, MP2L2

Network

Network Protocol & Service	IPv4/v6, TCP, UDP, PPPoE, HTTP, HTTPS, DNS, DDNS, NTP, RTP, RTSP, RTCP, SMTP, FTP, IGMP, ICMP, ARP, UPnP, QoS, SNMP, TLS 1.2, IEEE 802.1X
Ethernet Port	1 x Ethernet (10/100 Base-T), RJ-45 connector
Security	IP address filtering, HTTPS encryption, Password protected user level

Temperature Measurement

Temperature Measurement Rules	3 types (point, area, line), up to 21 rules in total (10 points, 10 areas, 1 line)
Temperature Range	-20°C ~ 150°C (-4°F ~ 302°F)
Temperature Accuracy	±8°C

Detection Range

Triggering Analytics Event Notification	(People 1.8x0.5m) 30m (Vehicle 1.4x4.0m) 85m (Supported Analytics Events included Line Crossing Detection, Enter Area Detection and Exit Area Detection for People, Vehicle and any objects.)
Triggering Temperature Notification	(Object 0.2x0.2m) 13.6m (Object 1x1m) 68m
Triggering Fire Detection Event Notification	(Object 0.2x0.2m) 62m
Triggering Smoking Detection Event Notification	6.2m
Observation Range	Detection: People 182m; Vehicle 559m Recognition: People 46m; Vehicle 140m Identification: People 23m; Vehicle 70m (People: 1.8 x 0.5m) (Vehicle: 1.4 x 4.0m)

Event

Event Trigger	External device through digital input, Sound detection, Temperature Exception Detection (up to 10 points, 10 areas and 1 line), Intelligent event detection
Event Response	Send E-mail Notification, Flashing alarm light, Play alert sound, Save video to storage, Activate external device through digital output

System

Language	Multi-Language, English, Traditional Chinese
----------	--

Integration

ONVIF Compliant	Yes
-----------------	-----

Interface

Serial Port	1 x RS-485
Audio Interface	1/1, 3.5mm Phone Jack, Built-in Speaker
Analog Video Output	1 x BNC connector, for installation only
Digital Input/Output	2/2

General

Power Source	DC 12V, PoE Class 3 (IEEE802.3af)
Power Consumption	6 W (DC), 6.5 W (PoE)
Weight	1760g (3.88lb)
Dimensions	(L x W x H): 358.3mm x 113.5mm x 115.2mm (14.10" x 4.47" x 4.53")
Environmental Casing	Weatherproof (IP68), Vandal proof metal casing (IK10)
Corrosion Protection	Optional for project request. Chassis corrosion resistance at the seashore approximately 3 years.
Operating Temperature	-40°C ~ 60°C (-40°F ~ 140°F)
Approvals	CE Class B, FCC Class B, IP68, IK10 (metal casing)
Real-time Clock (RTC)	Yes
Warranty	3 Year(s). For extended warranty offering, see http://www.acti.com/support/warranty

► Photo Indication



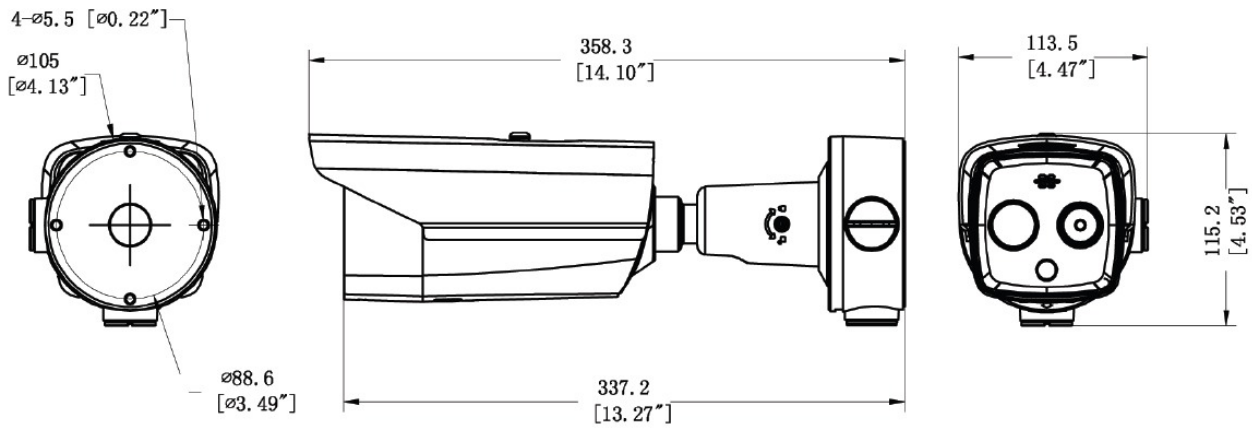

► Dimension Diagram



Unit: mm [inch]

▶ Related Products

Mounting Accessories - Camera Mount

PMAX-0407		Corner Mount (for A42x, A42xD, A570, A570-P1, A570-P2, A7xD, A82xD, VMGB-359, VMGB-359-P1)
PMAX-0524		Pole Mount (for A46, A421, A422, A423, A425, VMGB-359), supports 2.64" to 5" Poles

Note: Some mounting accessories may need additional accessories for installation. Please check www.acti.com/mountingselector for more information.









Power Supply Accessories - Power Adapter

PPBX-0013		Power Adapter AC 100~240V (EU), for A3x, A4x, A88, A9x, Z31, Z8x, Z9x
PPBX-0014		Power Adapter AC 100~240V (UK), for A3x, A4x, A88, A9x, Z31, Z8x, Z9x
PPBX-0026		Power Adapter AC 100~240V (US), for A3x, A4x, A7x, A88, A9x, Z3x, Z4x, Z7x, Z8x, Z9x

Power Supply Accessories - PoE Injector

PPOE-0107		High PoE Injector IEEE 802.3at compliant, AC 100~240V, with universal connectors (for A416, A418, B913, B923, B934, Q450, Q75, VMGB-60X, Z37, Z71, Z952)
-----------	---	--

Network & Storage Peripherals - Data Switch

PPSW-0102		PLANET FGSD-1011HP 8-Port 802.3at PoE Switch (PoE Budget 120W)
PPSW-0108		8-Port Gigabit 802.3at Managed PoE Switch (PoE Budget 120W)
PPSW-0109		8-Port 802.3at Smart Managed PoE Switch (PoE Budget 120W)
PPSW-1101		PLANET GS-4210-24PL4C 24-Port Gigabit 802.3at Managed PoE Switch (PoE Budget 440W)
PPSW-1107		24-port 10/100/1000Mbps PoE, Smart Managed Gigabit Ethernet PoE Switch
PPSW-2105		4-Port 802.3at Smart Managed Gigabit PoE Switch
PPSW-3101		16-Port Gigabit 802.3at Managed PoE Switch (PoE Budget 240W)
PPSW-3103		16-Port 802.3at Smart Managed PoE Switch (PoE Budget 250W)
PPSW-3104		16-Port 802.3at Smart Managed PoE Switch (PoE Budget 250W)

PPSW-3402



16-Port 10/100/1000T 802.3bt PoE + 8-Port 10/100/1000T + 4-Port 10G SFP+ Managed Ethernet Switch

PPSW-4205



24-Port 10/100/1000T 802.3at PoE + 2-Port 100/1000X SFP Managed Switch (PoE Budget 300W)