

Z810

8MP Deep Learning AI 4.3x Outdoor Zoom Dome with IR LED 60m, WDR 130dB



- 8 Megapixel, 4.3x, Zoom Dome
- Deep Learning AI
- IR LED 60m, Extreme WDR (130 dB)
- Color Min. Illumination 0.005 lux
- Counting
- DORI (86.9-372.4 / 34.8-149.0 / 17.4-74.5 / 8.7-37.2m)
- Weatherproof (IP68), Vandal proof (IK10), UL Listed

► Specifications

Product Profile

Product Type	Zoom Dome
Application Environment	Outdoor
Maximum Resolution	8MP
Image Sensor	Progressive Scan CMOS
Sensor Size	1/2.7 "
Day / Night	Yes
Low Light Sensitivity	Superior
Minimum Illumination	Color: 0.005 lux at F1.6 (AGC on); B/W: 0 lux (IR LED on)
Mechanical IR Cut Filter	Yes
IR LED	Adaptive IR LED x 3 (850 nm)
IR Working Distance	60m
Electronic Shutter	1-1/100000 second (manual mode); 1-1/100000 second (auto mode)
S/N Ratio	75 dB

Lens

Focal Length	Zoom, f2.8-12mm
--------------	-----------------

Aperture	F1.6-F3.3
Zoom Ratio	4.3x optical zoom
Zoom Application	Camera Installation
Iris	Fixed iris
Focus	Auto focus
Horizontal Viewing Angle	99.8° - 31.1°
Vertical Viewing Angle	53.1° - 17.7°
Viewing Angle Adjustment	Pan: 0°-355°, Tilt: 0°-80°, Rotation: 0°-355°

Video

Compression	H.265 Adaptive Stream, H.264 (Baseline/ Main/ High profile), MJPEG
Maximum Frame Rate vs. Resolution	20 fps at 3840 x 2160 30 fps at 3072 x 1728 30 fps at 2560 x 1440 30 fps at 1920 x 1080 30 fps at 1280 x 720 30 fps at 720 x 576 30 fps at 640 x 360 30 fps at 704 x 288 30 fps at 352 x 288
Multi-Streaming	Simultaneous triple streams
Digital Noise Reduction	2D + 3D DNR
Wide Dynamic Range	Extreme WDR (130 dB)
Image Orientation	Flip, Mirror, Rotation (Corridor mode)
Image Enhancement	White Balance, Backlight compensation (BLC), Brightness, Contrast, Sharpness, Automatic gain control (AGC), Defogging
Privacy Mask	4 configurable regions
Text Overlay	Yes
Built-in Analytics	People Flow Counting, People Density Counting, People Detection, Vehicle Detection, Tampering Detection, Intrusion Detection (Forbidden Area Detection), Object Line Crossing Detection, Object Enter Area Detection, Object Exit Area Detection, Appear in Area

Analytics

Deep Learning AI	2.0
------------------	-----

Audio

Audio Type	2-way, Built-in Microphone, Line-in, Line-out
------------	---

Network

Network Protocol & Service	IPv4, TCP, UDP, DHCP, HTTP, HTTPS, DNS, DDNS, NTP, RTP, RTSP, RTCP, SMTP, FTP, IGMP, ICMP, ARP, UPnP, QoS, SNMP, IEEE 802.1X
Ethernet Port	1 x Ethernet (10/100 Base-T), RJ-45 pigtail connector
Security	IP address filtering, HTTPS encryption, Password protected user level

Detection Range

Observation Range	Detection: 86.9m-372.4m Observation: 34.8m-149.0m Recognition: 17.4m-74.5m Identification: 8.7m-37.2m
-------------------	---

Event

Event Trigger	Video motion detection (4 regions), External device through digital input, Sound detection, Intelligent event detection
---------------	---

Event Response

E-mail notification with snapshots, Save video or snapshot to storage, Upload snapshot to FTP server, Activate external device through digital output

Integration

ONVIF Compliant	Yes, Profile S, Profile G, Profile T
Web Browser	IE 11, Google Chrome, Microsoft Edge, Firefox

Interface

Digital Input/Output	1/1 (Cable with Terminal block)
Operating Button	Reset Button

General

Power Source	DC 12V, PoE (IEEE802.3af)
Power Consumption	12.95 W (PoE)
Weight	976.5g (2.15lb)
Dimensions	(Ø x H): 148mm x 111.4mm (5.8" x 4.4")
Environmental Casing	Weatherproof (IP68), Vandal proof metal casing (IK10)
Corrosion Protection	Optional for project request. Chassis corrosion resistance at the seashore approximately 3 years.
Operating Temperature	-30°C ~ 60°C (-22°F ~ 140°F)
Approvals	CE Class B, FCC Class B, IP68, IK10 (metal casing), UL Listed
Color	White
Material	Metal Plastic
Real-time Clock (RTC)	Yes
Warranty	2 Year(s). For extended warranty offering, see http://www.acti.com/support/warranty

► Photo Indication



- 1 DC 12V Power Input
- 2 Audio Input / Output
- 3 Digital Input / Output
- 4 Ethernet Port
- 5 Built-in Microphone
- 6 Reset Button



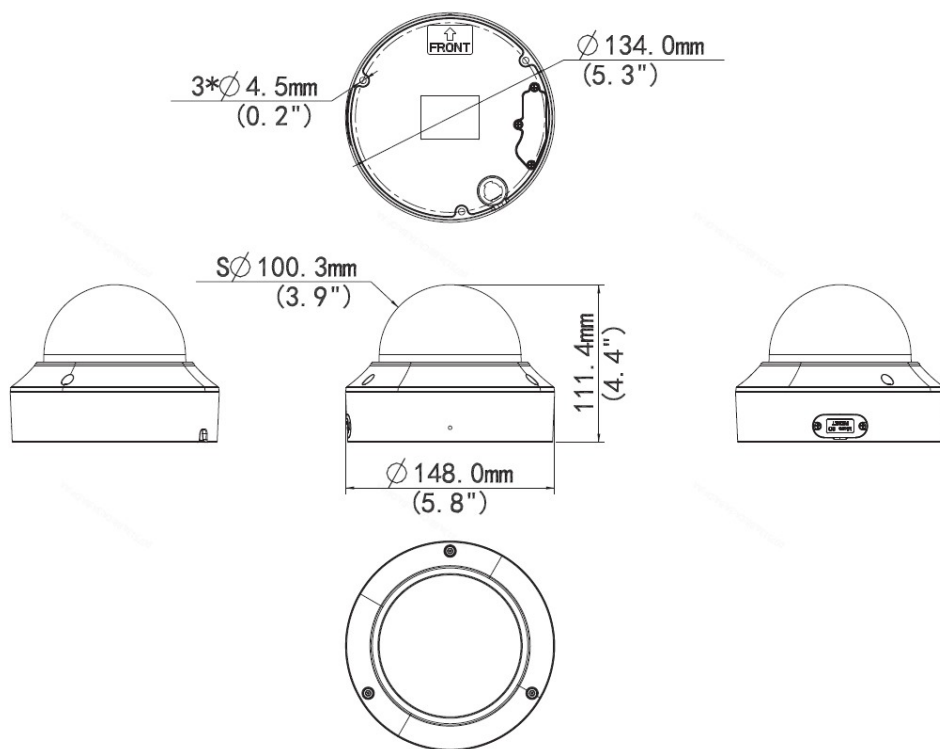









► Dimension Diagram



Unit: mm [inch]

► Related Products

Mounting Accessories - Camera Mount

PMAX-0102		Straight Tube
PMAX-0103		Straight Tube with Bracket
PMAX-0104		Extension Tube
PMAX-0127		Mount Kit (for Z83, Z84, Z810, A811, A818)
PMAX-0128		Pendant Mount (for Z5x, Z724, Z85, Z86, Z87, Z810, Z972, Q550)
PMAX-0134		Extension Tube, 200 mm (for Z5x, Z724, Z85, Z86, Z87, Z810, Z972, Q550)
PMAX-0367		Wall Mount with Built-in Junction Box (for Z83, Z84, Z810, Z818)
PMAX-0538		Pole Mount (for Z3x, Z4x, Z5x, Z724, Z8x, Z9x, Z972, A7x, Q550, K3x, K5x, K7x) , supports 2.64" to 5" Poles
PMAX-0723		Junction Box (for Z83, Z84)
PMAX-0808		Converter Ring, 1.5" NPT for Third-Party Mounting Accessories
PMAX-1031		Flush Mount (for Z83, Z84)
PMAX-1405		Mount Kit (for A826)
PMAX-1501		Cable Gland for Outdoor Domes (except Hemispheric Domes)

Note: Some mounting accessories may need additional accessories for installation. Please check www.acti.com/mountingselector for more information.

Power Supply Accessories - Power Adapter

PPBX-0013		Power Adapter AC 100~240V (EU), for A3x, A4x, A88, A9x, Z31, Z8x, Z9x
PPBX-0014		Power Adapter AC 100~240V (UK), for A3x, A4x, A88, A9x, Z31, Z8x, Z9x
PPBX-0026		Power Adapter AC 100~240V (US), for A3x, A4x, A7x, A88, A9x, Z3x, Z4x, Z7x, Z8x, Z9x

Power Supply Accessories - PoE Injector

PPOE-0107



High PoE Injector IEEE 802.3at compliant, AC 100~240V, with universal connectors (for A416, A418, B913, B923, B934, Q450, Q75, VMGB-60X, Z37, Z71, Z952)