

# Z72

## 4MP LightGuard f2.8mm Outdoor Fixed Turret with IR LED 40m, WDR 120dB



- 4 Megapixel, f2.8mm, Fixed Turret
- LightGuard
- IR LED 40m, Superior WDR (120 dB)
- Color Min. Illumination 0.003 lux
- DORI (63 / 25.2 / 12.6 / 6.3m)
- Weatherproof (IP68), Vandal proof (IK10), UL Listed

### ► Specifications

#### Product Profile

Product Type	Fixed Turret
Application Environment	Outdoor
Maximum Resolution	4MP
Image Sensor	Progressive Scan CMOS
Sensor Size	1/2.7 "
Day / Night	Yes
Low Light Sensitivity	Superior
LightGuard	Yes
Minimum Illumination	Color: 0.003 lux at F1.6 (AGC on); B/W: 0 lux (IR LED on)
Mechanical IR Cut Filter	Yes
IR LED	Adaptive IR LED x 1 (850 nm)
IR Working Distance	40m
Electronic Shutter	1-1/100000 second (manual mode); 1-1/100000 second (auto mode)
S/N Ratio	75 dB

<b>Lens</b>	
Focal Length	Fixed focal, f2.8mm
Aperture	F1.6
Iris	Fixed iris
Focus	Fixed focus
Horizontal Viewing Angle	101.1°
Vertical Viewing Angle	55.3°
Viewing Angle Adjustment	Pan: 0°-360°, Tilt: 0°-80°, Rotation: 0°-360°

<b>Video</b>	
Compression	H.265 Adaptive Stream, H.264 (Baseline/ Main/ High profile), MJPEG
Maximum Frame Rate vs. Resolution	25 fps at 2688 x 1520 25 fps at 2560 x 1440 30 fps at 2304 x 1296 30 fps at 1920 x 1080 30 fps at 1280 x 720 30 fps at 720 x 576 30 fps at 704 x 288 30 fps at 640 x 360 30 fps at 352 x 288
Multi-Streaming	Simultaneous dual streams
Digital Noise Reduction	2D + 3D DNR
Wide Dynamic Range	Superior WDR (120 dB)
Image Orientation	Flip, Mirror, Rotation (Corridor mode) (90°, 180°, 270°)
Image Enhancement	Wide Dynamic Range, Backlight compensation (BLC), Brightness, Contrast, Sharpness, Automatic gain control (AGC), Defogging
Privacy Mask	4 configurable regions
Text Overlay	Yes
Built-in Analytics	People Detection, Vehicle Detection, Tampering Detection, Intrusion Detection (Forbidden Area Detection)

<b>Audio</b>	
Audio Type	1-way, Built-in Microphone
Audio Compression	G.711

<b>Network</b>	
Network Protocol & Service	IPv4, TCP, UDP, DHCP, PPPoE, HTTP, HTTPS, DNS, DDNS, NTP, RTP, RTSP, RTCP, SMTP, FTP, IGMP, ICMP, ARP, UPnP, SNMP
Ethernet Port	1 x Ethernet (10/100 Base-T), RJ-45 pigtail connector

<b>Detection Range</b>	
Observation Range	Detection: 63m Observation: 25.2m Recognition: 12.6m Identification: 6.3m

<b>Event</b>	
Event Trigger	Video motion detection (4 regions), Sound detection, Intelligent event detection
Event Response	E-mail notification with snapshots, Upload snapshot to FTP server, Save video or snapshot to storage

<b>Integration</b>	
ONVIF Compliant	Yes, Profile S, Profile G, Profile T
Web Browser	IE 11, Google Chrome, Microsoft Edge, Firefox

**Interface**

Operating Button	No
------------------	----

**General**

Power Source	DC 12V, PoE Class 3 (IEEE802.3af)
Power Consumption	6 W (PoE)
Weight	344.5g (0.76lb)
Dimensions	(Ø x H): 118mm x 95mm (4.6" x 3.8")
Environmental Casing	Weatherproof (IP68), Vandal proof metal casing (IK10)
Corrosion Protection	Optional for project request. Chassis corrosion resistance at the seashore approximately 3 years.
Operating Temperature	-30°C ~ 50°C (-22°F ~ 122°F)
Operating Humidity	10% - 95% RH, non-condensing
Approvals	CE Class B, FCC Class B, IP68, IK10 (metal casing), UL Listed
Real-time Clock (RTC)	No
Warranty	2 Year(s). For extended warranty offering, see <a href="http://www.acti.com/support/warranty">http://www.acti.com/support/warranty</a>

### ► Photo Indication





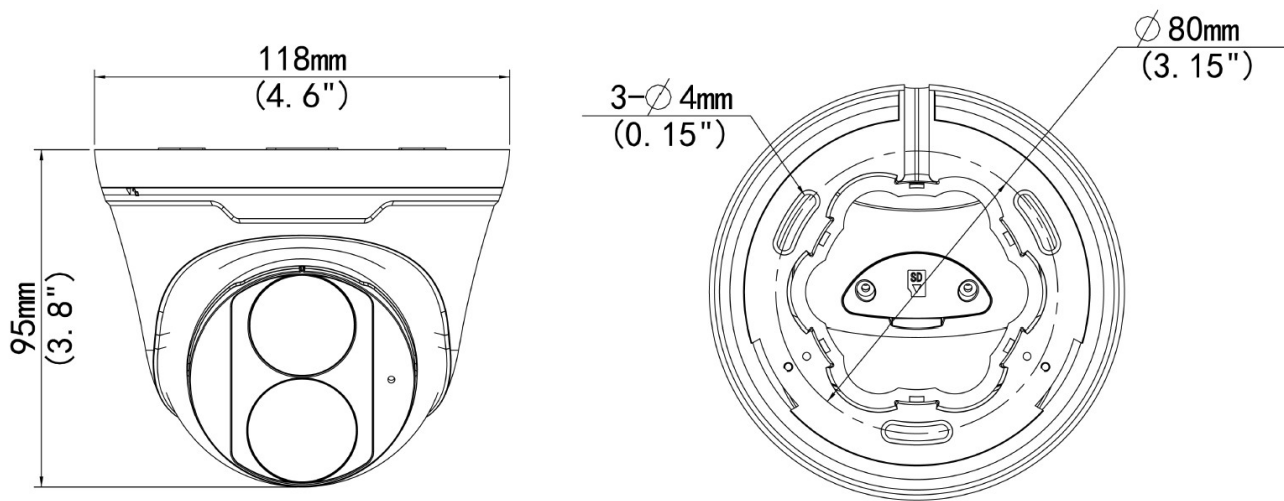

### ► Dimension Diagram



Unit: mm [inch]

## ▶ Related Products

### Mounting Accessories - Camera Mount

PMAX-0128		Pendant Mount (for Z5x, Z724, Z85, Z86, Z87, Z810, Z972, Q550)
PMAX-0349		Wall Mount with Built-in Junction Box (for Z71, Z72)
PMAX-0365		Wall Mount with Built-in Junction Box (for Y7x, Z5x, Z7x, Z91x)
PMAX-0532		Pole Mount (for Z5x, Z724, Z8x, Z9x, Z972, A7X, Q550), supports 2.6" to 5" Poles
PMAX-0727		Junction Box (for Z71, Z72)

**Note:** Some mounting accessories may need additional accessories for installation. Please check [www.acti.com/mountingselector](http://www.acti.com/mountingselector) for more information.

### Power Supply Accessories - Power Adapter

PPBX-0013		Power Adapter AC 100~240V (EU), for A3x, A4x, A88, A9x, Z31, Z8x, Z9x
PPBX-0014		Power Adapter AC 100~240V (UK), for A3x, A4x, A88, A9x, Z31, Z8x, Z9x
PPBX-0026		Power Adapter AC 100~240V (US), for A3x, A4x, A7x, A88, A9x, Z3x, Z4x, Z7x, Z8x, Z9x

### Power Supply Accessories - PoE Injector

PPOE-0107		High PoE Injector IEEE 802.3at compliant, AC 100~240V, with universal connectors (for A416, A418, B913, B923, B934, Q450, Q75, VMGB-60X, Z37, Z71, Z952)
-----------	---	--