

Z84

4MP 4.3x Outdoor Zoom Dome with IR LED 40m, WDR 120dB



- 4 Megapixel, 4.3x, Zoom Dome
- IR LED 40m, Superior WDR (120 dB)
- Weatherproof (IP68), Vandal proof (IK10), UL Listed

► Specifications

Product Profile

Product Type	Zoom Dome
Application Environment	Outdoor
Maximum Resolution	4MP
Image Sensor	Progressive Scan CMOS
Sensor Size	1/3 "
Effective Pixels	2688(H) X 1520(V) (4.09 MP)
Day / Night	Yes
Low Light Sensitivity	Superior
Minimum Illumination	Color: 0.01 lux; B/W: 0 lux (IR LED on)
Mechanical IR Cut Filter	Yes
IR LED	Adaptive IR LED
IR Working Distance	40m
Electronic Shutter	1-1/100000 second (manual mode); 1-1/100000 second (auto mode)
S/N Ratio	52 dB

Lens

Focal Length	Zoom, f2.8-12mm
Aperture	F1.6
Zoom Ratio	4.3x optical zoom
Zoom Application	Camera Installation
Iris	Fixed iris
Focus	Auto focus
Lens Mount	Board mount
Horizontal Viewing Angle	91° - 27°
Vertical Viewing Angle	54.4° - 13.7°
Viewing Angle Adjustment	Pan: 0°-360°, Tilt: 0°-80°, Rotation: 0°-360°

Video

Compression	H.265, H.264 (Baseline/ Main profile), MJPEG
Maximum Frame Rate vs. Resolution	20 fps at 2592 x 1520 20 fps at 2048 x 1520 20 fps at 1920 x 1080 20 fps at 1280 x 720 20 fps at 640 x 360 20 fps at 704 x 576 20 fps at 704 x 288 20 fps at 352 x 288
Bit Rate Mode	Constant, Variable
Multi-Streaming	Simultaneous triple streams
Digital Noise Reduction	2D + 3D DNR
Wide Dynamic Range	Superior WDR (120 dB)
Image Orientation	Flip, Mirror
Image Enhancement	White Balance, Backlight compensation (BLC), Brightness, Contrast, Sharpness, Automatic gain control (AGC), Defogging
Privacy Mask	4 configurable regions
Text Overlay	Yes
Built-in Analytics	Tampering Detection, Intrusion Detection (Forbidden Area Detection)*
Server-based Analytics	Object Line Counting, People Counting, Face Detection, Object Based Motion Detection, Tamper, Object Line Crossing Detection, Object Enter Area Detection, Missing Object Detection, Unattended Object Detection, Smoke Detection, Heat Map, Dwell Time, Direction Detection, Automatic License Plate Recognition, People Queue Detection, (Require PC-based or standalone IVS or ALPR Server. Contact ACTi support for recommendations on how to maximize analytical accuracy)

Network

Network Protocol & Service	IPv4, TCP, UDP, DHCP, HTTP, HTTPS, DNS, DDNS, NTP, RTP, RTSP, RTCP, SMTP, FTP, IGMP, ICMP, ARP, UPnP, QoS, SSL/TLS
Ethernet Port	1 x Ethernet (10/100 Base-T), RJ-45 pigtail connector
Security	IP address filtering, HTTPS encryption, Password protected user level

Event

Event Trigger	Video motion detection (4 regions), Intelligent event detection.
Event Response	E-mail notification with snapshots, Upload snapshot to FTP server, Save video or snapshot to storage

Integration

ONVIF Compliant	Yes, Profile S, Profile G, Profile T
Web Browser	IE 11

Interface

Operating Button	Reset Button
------------------	--------------

General

Power Source	DC 12V, PoE Class 3 (IEEE802.3af)
Power Consumption	6 W (PoE)
Weight	909g (2.004lb)
Dimensions	(Ø x H): 148mm x 111.3mm (5.8" x 4.4")
Environmental Casing	Weatherproof (IP68), Vandal proof (IK10)
Corrosion Protection	Optional for project request. Chassis corrosion resistance at the seashore approximately 3 years.
Operating Temperature	-40°C ~ 60°C (-40°F ~ 140°F)
Operating Humidity	10% - 95% RH, non-condensing
Approvals	CE Class B, FCC Class B, EAC, IP68, IK10, UL Listed
Warranty	2 Year(s). For extended warranty offering, see http://www.acti.com/support/warranty

* Intrusion detection is integrated with ZNR series.

▶ Photo Indication



- 1 DC 12V Power Input
- 2 Ethernet Port
- 3 Reset Button

▶ Dimension Diagram

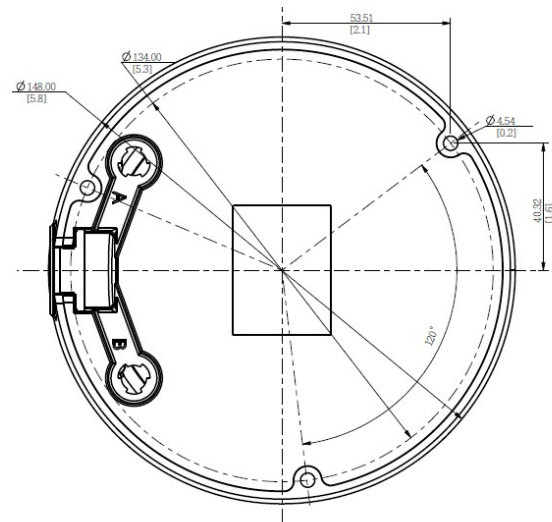
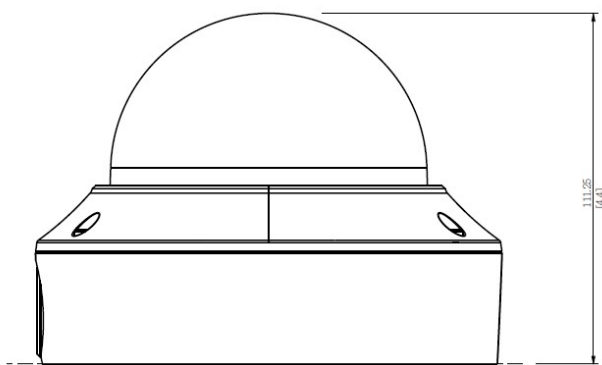



















Unit:mm[inch]

Unit: mm [inch]

► Related Products

Mounting Accessories - Camera Mount

PMAX-0102		Straight Tube
PMAX-0103		Straight Tube with Bracket
PMAX-0104		Extension Tube
PMAX-0127		Mount Kit (for Z83, Z84, Z810, A811, A818)
PMAX-0302		Gooseneck with Bracket
PMAX-0303		Gooseneck
PMAX-0357		Wall Mount (for A826)
PMAX-0367		Wall Mount with Built-in Junction Box (for Z83, Z84, Z810, Z818)
PMAX-0402		Corner Mount
PMAX-0503		Pole Mount (for PMAx-0102, PMAx-0312, PMAx-0313, PMAx-0314, PMAx-0702, PMAx-1106, PMAx-1107), supports 5.25" to 8.5" Poles
PMAX-0505		Pole Mount (for B4x, B41x, E44, E45, E46, E48, E44A, E45A, E46A, E41x, I4x, PMAx-0312, PMAx-0313, PMAx-0314, PMAx-0330), supports 2" to 3" Poles
PMAX-0538		Pole Mount (for Z3x, Z4x, Z5x, Z724, Z8x, Z9x, Z972, A7x, Q550, K3x, K5x, K7x) , supports 2.64" to 5" Poles
PMAX-0702		Junction Box for PTZ and Dome Cameras
PMAX-0723		Junction Box (for Z83, Z84)
PMAX-0808		Converter Ring, 1.5" NPT for Third-Party Mounting Accessories
PMAX-1031		Flush Mount (for Z83, Z84)
PMAX-1405		Mount Kit (for A826)
PMAX-1501		Cable Gland for Outdoor Domes (except Hemispheric Domes)

Note: Some mounting accessories may need additional accessories for installation. Please check www.acti.com/mountingselector for more information.

Power Supply Accessories - Power Adapter

PPBX-0013



Power Adapter AC 100~240V (EU), for A3x, A4x, A88, A9x, Z31, Z8x, Z9x

PPBX-0014



Power Adapter AC 100~240V (UK), for A3x, A4x, A88, A9x, Z31, Z8x, Z9x

PPBX-0026



Power Adapter AC 100~240V (US), for A3x, A4x, A7x, A88, A9x, Z3x, Z4x, Z7x, Z8x, Z9x

Power Supply Accessories - PoE Injector

PPOE-0107



High PoE Injector IEEE 802.3at compliant, AC 100~240V, with universal connectors (for A416, A418, B913, B923, B934, Q450, Q75, VMGB-60X, Z37, Z71, Z952)