

# A956

## 2MP Deep Learning AI 40x Outdoor PTZ with IR LED 250m, WDR 150dB



- 2 Megapixel, 40x, PTZ
- Deep Learning AI
- IR LED 250m, Extreme WDR (150 dB)
- Color Min. Illumination 0.002 lux
- Frame Rate 60fps
- PTZ Auto Tracking, 360° endless
- Smart Motion Detection, Smart Intrusion Protection, Object Metadata
- Face Recognition, Counting
- Automatic License Plate Recognition
- Weatherproof (IP66), Vandal proof (IK10)

### ► Specifications

#### Product Profile

Product Type	PTZ
Product Application	Face, People and Car Detection, ALPR
Application Environment	Outdoor
Maximum Resolution	2MP
Image Sensor	Progressive Scan CMOS
Sensor Size	1/2.7 "
Effective Pixels	1945(H) X 1097(V) (2.13 MP)
Day / Night	Yes
Low Light Sensitivity	Extreme
Minimum Illumination	Color: 0.002 lux; B/W: 0.001 lux; B/W: 0 lux (IR LED on)
Mechanical IR Cut Filter	Yes
IR Sensitivity Range	700-1100nm
IR LED	Adaptive IR LED x 8 (850 nm)
IR Working Distance	250m
Electronic Shutter	1-1/10000 second (manual mode); 1-1/10000 second (auto mode)

S/N Ratio	75 dB
Number of Traffic Lanes	1

## Lens

Focal Length	Zoom, f4.3-170mm
Aperture	F1.6
Zoom Ratio	40x optical zoom, 10x digital zoom
Iris	P-Iris
Focus	Auto focus
Horizontal Viewing Angle	66.1° - 1.8°
Vertical Viewing Angle	39.8° - 1.1°

## PTZ

Manual Panning / Tilting Speed	0.1° - 90°/second, 0.1° - 55°/second
Preset Panning / Tilting Speed	300°/second, 300°/second
Panning Range	360° endless
Tilting Range	-20°~100°
PTZ Control	Remote manual control, Speed Control, Drag to Pan and Tilt, Click to Center, 256 preset points, Auto scan
Absolute Position	Yes

## Video

Compression	H.265 Adaptive Stream, H.264, MJPEG
Maximum Frame Rate vs. Resolution	60 fps at 1920 x 1080 30 fps at 1280 x 1024 30 fps at 1280 x 720 30 fps at 1024 x 768 30 fps at 800 x 600 30 fps at 720 x 480 25 fps at 720 x 576 30 fps at 640 x 480 30 fps at 352 x 240 25 fps at 352 x 288 30 fps at 320 x 240
Bit Rate Mode	Constant, Variable
Multi-Streaming	Simultaneous quad streams
Digital Noise Reduction	2D + 3D DNR
Wide Dynamic Range	Extreme WDR (150 dB)
Image Orientation	Flip, Mirror, Rotation (Corridor mode) (90°, 180°, 270°)
Image Enhancement	White Balance, Brightness, Contrast, Sharpness, Saturation, Backlight compensation (BLC), Digital Image Stabilizer (DIS, EIS)
Privacy Mask	5 configurable regions
Text Overlay	Yes

Built-in Analytics	Smart Motion Detection (People Detection, Vehicle Detection), Smart Intrusion Protection (, People Line Crossing Detection, People Intrusion Detection, People Enter Area Detection, People Exit Area Detection, Vehicle Line Crossing Detection, Vehicle Intrusion Detection, Vehicle Enter Area Detection, Vehicle Exit Area Detection), Tampering Detection, Missing Object Detection, Unattended Object Detection, Crowd Detection, People Loitering Detection, People Tracking, People Flow Counting, People Density Counting, Vehicle Flow Counting, Vehicle Density Counting, Vehicle Tracking, Face Detection, Face Capture, Face Matching, Face Recognition, Face Tracking, Object Metadata (, Age Detection, Gender Detection, Face Mask Detection, Vehicle Type Detection, Vehicle Driving Direction Detection), Stopped vehicle detection, Incorrect Direction Detection, License Plate Detection, Automatic License Plate Recognition, PTZ Auto Tracking
--------------------	---

**Analytics**

Camera Object Metadata	Age, Gender, Mask, Vehicle type, Vehicle driving direction
Deep Learning AI	2.0

**Audio**

Audio Type	2-way, Line-in, Line-out
Audio Compression	G.711, G.726, AAC, PCM

**Network**

Network Protocol & Service	IPv4, IPv6, TCP, UDP, DHCP, PPPoE, HTTP, HTTPS, DDNS, NTP, RTP, RTSP, SMTP, FTP, IGMP, ICMP, ARP, UPnP, QoS, SNMP, IEEE 802.1X
Ethernet Port	1 x Ethernet (10/100/1000 Base-T), RJ-45 connector
Security	IP address filtering, HTTPS encryption, Password protected user level, IEEE 802.1X network access control

**Detection Range**

Observation Range	Detection: People 2444m; Vehicle 2250m Observation: People 970m; Vehicle 893m Recognition: People 489m; Vehicle 450m Identification: People 244m; Vehicle 225m
-------------------	--

**Event**

Event Trigger	Video motion detection, External device through digital input, Sound detection, Intelligent event detection
Event Response	E-mail notification with snapshots, Save video to storage, Upload snapshot to FTP server, Activate external device through digital output

**System**

Watchdog	Support
----------	---------

**Integration**

Unified Solution	Fully compatible with ACTi software
Edge Recording	Support (integration with NVR by ONVIF Profile G)
ONVIF Compliant	Yes, Profile G, Profile T, Profile Q, Profile M
Web Browser	Microsoft Edge(IE mode), Microsoft Edge, Google Chrome, Firefox
Supported Countries	Austria / Azerbaijan / Belarus / Belgium / Bosnia and Herzegovina / Bulgaria / Croatia / Cyprus / Czechia / Denmark / Estonia / Finland / France / Georgia / Germany / Greece / Hungary / Ireland / Italy / Japan / Kyrgyzstan / Latvia / Lithuania / Luxembourg / Moldova / Monaco / Montenegro / Netherlands / Macedonia / Norway / Poland / Portugal / Romania / Serbia / Slovakia / Slovenia / Spain / Sweden / Switzerland / Taiwan / United Kingdom / Ukraine / United States / Vietnam

**Storage**

User Database	User Capacity: 10,000 (up to 5 images per person)
Blocklist/Allowlist	People, Vehicle

**Interface**

Audio Interface	1/1, Terminal block
Analog Video Output	1 x BNC connector
Digital Input/Output	4/2 (Terminal block)
Operating Button	Reset Button

**Installation**

Vehicle Capture Speed	Front-Installation: 80 km/h Side-Installation: 60 km/h
-----------------------	--

**General**

Power Source	AC 24V, High PoE 60W
Dimensions	(Ø x H): 207mm x 300mm (8.15" x 11.81")
Environmental Casing	Weatherproof (IP66), Vandal proof metal casing (IK10)
Corrosion Protection	Optional for project request. Chassis corrosion resistance at the seashore approximately 3 years.
Heater	Yes
Operating Temperature	-40°C ~55°C (-40°F ~ 131°F) heater on
Approvals	CE Class A, FCC Class A, IP66, IK10 (metal casing)
Color	White
Real-time Clock (RTC)	Yes
Warranty	3 Year(s) (1 year in continuous motion). For extended warranty offering, see <a href="http://www.acti.com/support/warranty">http://www.acti.com/support/warranty</a>



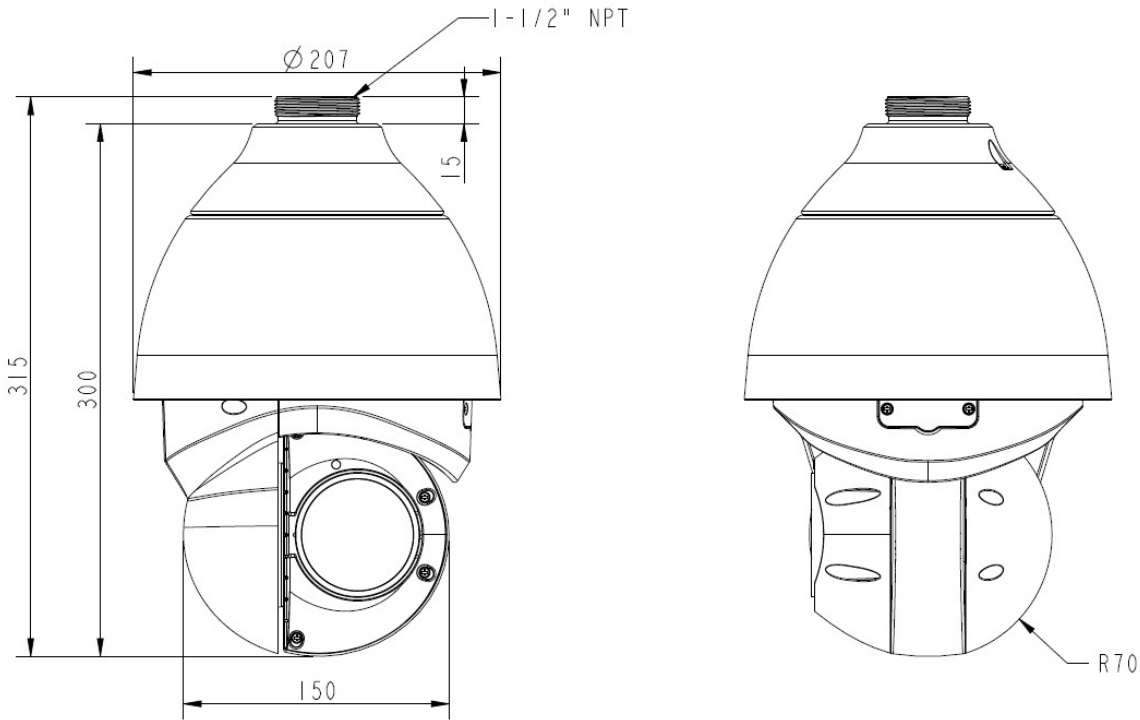



## ▶ Dimension Diagram



Unit: mm [inch]

## ▶ Related Products

### Mounting Accessories - Camera Mount

PMAX-0115		Pendant Mount (for A950, A951, A952, A956, Z950, Z952)
PMAX-0116		Straight Tube, 200 mm (for Z950)
PMAX-0117		Straight Tube (for Z950, Z952)
PMAX-0343		Gooseneck with Bracket with Converter Ring (for Q75)
PMAX-0344		Gooseneck with Converter Ring (for Q75)
PMAX-0346		Heavy Duty Wall Mount with Converter Ring (for Q75, A950, A951, A952, A956)
PMAX-0402		Corner Mount

PMA-0531



Pole mount for A951

PMA-0702



Junction Box for PTZ and Dome Cameras

**Note:** Some mounting accessories may need additional accessories for installation. Please check [www.acti.com/mountingselector](http://www.acti.com/mountingselector) for more information.

### Power Supply Accessories - Power Adapter

PPB-0022



Power Adapter for A951

### Power Supply Accessories - PoE Injector

PPOE-0202



High PoE injector 90Watt 10/100/1000M/Multi Gigabit PoE Injector (for A952, A956, Z953, Z954, Q83, Q84)