

# I29

## 2MP 36x Zoom Box with WDR 145dB



- 2 Megapixel, 36x, Zoom Box
- Extreme WDR (145 dB)
- Color Min. Illumination 0.002 lux
- Frame Rate 60fps

### ► Specifications

#### Product Profile

Product Type	Zoom Box
Application Environment	Indoor/Outdoor
Maximum Resolution	2MP
Image Sensor	Progressive Scan CMOS
Sensor Size	1/2.8 "
Effective Pixels	1945(H) X 1097(V) (2.13 MP)
Day / Night	Yes
Low Light Sensitivity	Extreme
Minimum Illumination	Color: 0.002 lux at F1.55; B/W: 0.001 lux at F1.55
Mechanical IR Cut Filter	Yes
IR Sensitivity Range	700-1100nm
Color to B/W Switch	ISP based switch, configurable
Electronic Shutter	1/5-1/32000 second (manual mode); 1/5-1/32000 second (auto mode)
Horizontal Resolution (TV Lines)	1800 TVL
S/N Ratio	75 dB

**Lens**

Focal Length	Zoom, f4.6-165.6mm
Aperture	F1.55-F5.0
Zoom Ratio	36x optical zoom
Zoom Application	Camera Installation, Auto Zoom by Event, Manual Operation
Iris	DC iris
Focus	Auto focus
Lens Mount	Board mount
Horizontal Viewing Angle	62.7° - 2.7°
Vertical Viewing Angle	38.5° - 1.6°

**PTZ**

Absolute Position	Yes
Pan, Tilt or Zoom protocol	Visca, Pelco-D, Pelco-P, ACTi URL command

**Video**

Compression	H.264 (Baseline/ Main/ High profile), MJPEG
Maximum Frame Rate vs. Resolution	60 fps at 1920 x 1080 60 fps at 1280 x 720 30 fps at 640 x 480 30 fps at 320 x 240
High Frame Mode	Support
Bit Rate	128Kbps - 12Mbps
Bit Rate Mode	Constant, Variable
Multi-Streaming	Simultaneous triple streams based on configurations of video resolution, compression format, and frame rate
Digital Noise Reduction	2D + 3D DNR
Wide Dynamic Range	Extreme WDR (145 dB)
Image Orientation	Flip, Mirror, Rotation (Corridor mode)
Image Enhancement	White Balance, Brightness, Contrast, Sharpness, Automatic gain control (AGC), Flickerless, Digital Image Stabilizer (DIS, EIS), Defogging
Privacy Mask	20 configurable 3D privacy masks
Text Overlay	Yes
On-Screen Graphics (Picture Overlay)	Yes
Built-in Analytics	Basic Face Detection, Object Based Motion Detection, Tampering Detection, Object Line Crossing Detection, Object Enter Area Detection, Missing Object Detection, Unattended Object Detection, Object Loitering Detection
Server-based Analytics	Object Line Counting, People Counting, Face Detection, Object Based Motion Detection, Tamper, Object Line Crossing Detection, Object Enter Area Detection, Missing Object Detection, Unattended Object Detection, Smoke Detection, Heat Map, Dwell Time, People Queue Detection, (Require PC-based or standalone IVS or ALPR Server. Contact ACTi support for recommendations on how to maximize analytical accuracy)

IVS performance	Certain algorithms may require more computing power, which may limit the number of algorithms that can be concurrently used in the camera. Please test the actual performance before using in a project.
-----------------	--

## Audio

Audio Type	2-way, Line-in, Line-out
Audio Compression	8 kHz, 16 bit encoding, Mono, PCM, G.711

## Network

Network Protocol & Service	IPv4/v6, TCP, UDP, DHCP, PPPoE, HTTP, HTTPS, DNS, DDNS, NTP, RTP, RTSP, RTCP, SMTP, FTP, IGMP, ICMP, ARP, Bonjour, UPnP, QoS, SNMP, IEEE 802.1X
Ethernet Port	1 x RJ-45 connector
Security	IP address filtering, HTTPS encryption, Password protected user level, Anonymous login, IEEE 802.1X network access control, Standard IoT Security (anti-hacking, anti-malware)

## Video Analytics

Analysis Source Type	Video
Metadata Accuracy	Standard

## Event

Event Trigger	Video motion detection (10 included and excluded polygonal regions), External device through digital input, Sound detection, Intelligent event detection, Video streams loss, System log buffer overrun, Remove system log, Logon events (Login Failure, Login Success, Block an Account)
Event Response	Notify control center, Go to Zoom preset point or preset tour, Change camera settings, Command other devices, E-mail notification with snapshots, Play the audio file, Push notification to mobile device, Save video to storage, Upload video to NVR server, Upload video or snapshot to FTP server, Activate external device through digital output

## System

System Monitor	CPU loading, memory usage and network statistics via API
System Log	Support
Watchdog	Support

## Integration

Unified Solution	Fully compatible with ACTi software
Software Development Kit	Yes
GPS Position	Manual setting
Edge Recording	Support (integration with NVR by ONVIF Profile G or proprietary protocol)**
ONVIF Compliant	Yes, Profile S, Profile G, Profile T, Profile Q, Profile M* (To be available through future firmware upgrade)
GB28181 Compliant	Yes
Web Browser	IE 11, Google Chrome, Microsoft Edge, Apple Safari
Auto Firmware Upgrade	Yes
SD Card Backup and Recovery	Automatically back up the video recordings from the memory card of camera to NVR 3 server with recovering lost videos after network connection recovery.

**Interface**

Serial Port	1 x RS-485/RS-422
Digital Input/Output	1/1
Operating Button	Reset Button

**General**

Power Source	DC 12V, PoE Class 3 (IEEE802.3af)
Power Consumption	9.4 W (PoE), 7.5 W (DC)
Weight	781g (1.721lb)
Dimensions	(W x H x D): 80.6mm x 71.4mm x 175.84mm (2.93" x 2.81" x 6.92")
Environmental Casing	Optional housing (IP66-IP68)
Mount Type	Bracket, Wall Mount, Ceiling Bracket
Heater	Yes
Starting Temperature	-10°C ~ 50°C (14°F ~ 122°F) within 30 minutes
Operating Temperature	-20°C ~ 50°C (-4°F ~ 122°F)
Operating Humidity	10% - 85% RH, non-condensing
Approvals	CE Class B, FCC Class B, EAC, UL (for optional PoE injector and power adapter)
Real-time Clock (RTC)	Yes
Warranty	3 Year(s). For extended warranty offering, see <a href="http://www.acti.com/support/warranty">http://www.acti.com/support/warranty</a>

\*\* Edge Recording function is integrated with NVR 3 Corporate / NVR 3 Business / INR / GNR series.

## ► Photo Indication

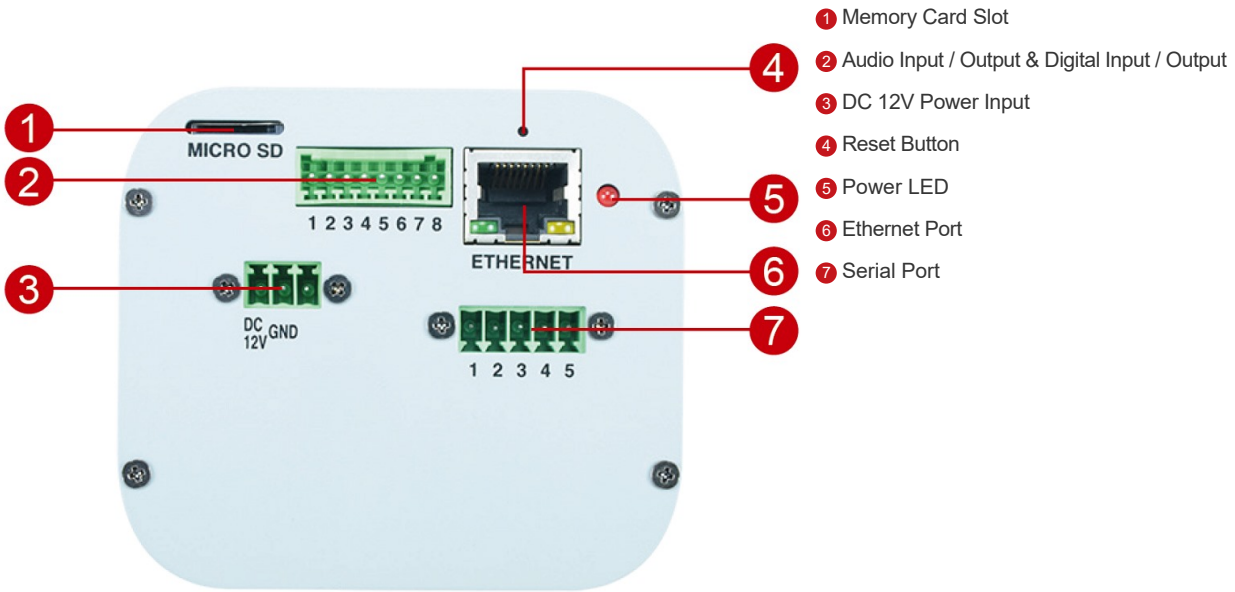



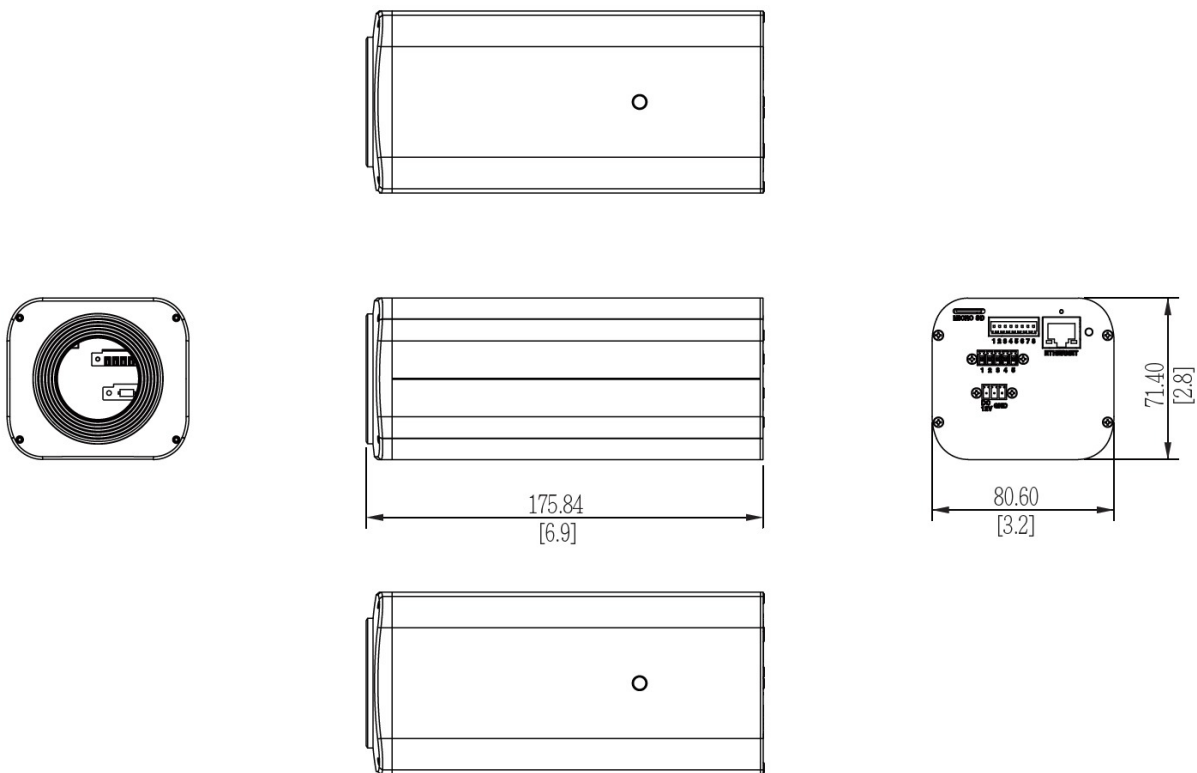



## ► Dimension Diagram



Unit: mm [inch]









## ▶ Related Products

### Mounting Accessories - Camera Mount



PMAX-0402		Corner Mount
PMAX-0503		Pole Mount (for PMAX-0102, PMAX-0312, PMAX-0313, PMAX-0314, PMAX-0702, PMAX-1106, PMAX-1107), supports 5.25" to 8.5" Poles
PMAX-0508		Pole Mount (for PMAX-0203, PMAX-0204, PMAX-0205, PMAX-0206, PMAX-0704), supports 3" to 9" Poles
PMAX-0704		Junction Box (for A4x, B4x, B41x, E44, E45, E46, E48, E44A, E45A, E46A, E41x, I4x, PMAX-0203~PMAX-0205)
PMAX-1105		Bracket for Indoor Box Cameras (for B2x)
PMAX-1106		Bracket for Outdoor Box Cameras (KCM-5211E, KCM-5511, KCM-5611, Box Cameras with Outdoor Housing)

**Note:** Some mounting accessories may need additional accessories for installation. Please check [www.acti.com/mountingselector](http://www.acti.com/mountingselector) for more information.

### Enclosures - Box Camera Housing

PMAX-0200		Outdoor Housing with Heater and Fan (110V)
PMAX-0201		Outdoor Housing with Heater and Fan (220V)
PMAX-0202		Outdoor Housing
PMAX-0203		Heavy Duty Outdoor Housing with Heater and Fan (230V) and Bracket
PMAX-0204		Heavy Duty Outdoor Housing with Heater and Fan (110V) and Bracket
PMAX-0206		PoE Heavy Duty Outdoor Housing with Heater, Fan, Defogger and Bracket
PMAX-0208		Explosion Proof Housing with Heater, Fan (AC 110V~220V) and Bracket
PMAX-0210		Stainless Steel Housing with Heater, Fan (AC 110V~220V) and Bracket

### Enclosures - PTZ & Positioning Housing

PMAX-0221		POE Explosion-proof Stainless Steel SUS316 Positioning Housing, with Heater, Fan and IR
PMAX-0222		POE Explosion-proof Stainless Steel SUS316 Positioning Housing, with Fan and Heater

## Power Supply Accessories - Power Adapter

PPBX-0011



Power Adapter AC 100~240V, with universal connectors for all DC12V powered devices

## Network & Storage Peripherals - Data Switch

PPSW-0102



PLANET FGSD-1011HP 8-Port 802.3at PoE Switch (PoE Budget 120W)

PPSW-1101



PLANET GS-4210-24PL4C 24-Port Gigabit 802.3at Managed PoE Switch (PoE Budget 440W)

PPSW-3100



PLANET FGSW-1816HPS 16-Port 802.3at PoE Switch (PoE Budget 220W)

## Extenders - PoE Extender

PPEX-0100



Veracity OUTREACH Max Power over Ethernet (PoE) Extender

## Extenders - PoE over Coaxial Extender Kit

PPOC-0100



Planet LRP-101C-KIT Power over Coax Adapter Kit

## Audio Devices - Microphone

PMIC-0100



Active Microphone Omnidirectional for all Cameras with Line-in Audio

## Illuminators - IR LED Illuminator

PLED-0200



SPINLUX (SL-A2IRXX10-24CL) IR Illuminator 10° Angle with 120 m approx. range

PLED-0201



SPINLUX (SL-A2IRXX25-24CL) IR Illuminator 25° Angle with 50 m approx. range

## Other Accessories - Accessory Part

R707-10000



Mounting Block (for D2x, E2x, B2x, I2x)