

B511A

12MP f1.65mm Indoor Hemispheric Dome with IR LED 20m, WDR 130dB



- 12 Megapixel, f1.65mm, Hemispheric Dome
- 1/1.7" Sensor, IR LED 20m, Extreme WDR (130 dB)
- Color Min. Illumination 0.003 lux

► Specifications

Product Profile

Product Type	Hemispheric Dome
Application Environment	Indoor
Maximum Resolution	12MP
Image Sensor	Progressive Scan CMOS
Sensor Size	1/1.7 "
Effective Pixels	4072(H) X 3046(V) (12.4 MP)
Day / Night	Yes
Low Light Sensitivity	Superior
Minimum Illumination	Color: 0.003 lux at F2.8; B/W: 0 lux (IR LED on)
Mechanical IR Cut Filter	Yes
IR Sensitivity Range	700-1100nm
IR LED	Adaptive IR LED x 12 (850 nm)
IR Working Distance	20m
Color to B/W Switch	ISP based switch, configurable
Electronic Shutter	1/5-1/16000 second (manual mode); 1/5-1/16000 second (auto mode)

Horizontal Resolution (TV Lines)	2250 TVL
S/N Ratio	75 dB

Lens

Focal Length	Fixed focal, f1.65mm
Aperture	F2.8
Iris	Fixed iris
Focus	Fixed focus
Lens Mount	Board mount
Horizontal Viewing Angle	198.5° (overview area) 121.1° (high detail area)
Vertical Viewing Angle	198.5° (Fisheye View)
Overview, Zoom and Tracking (OZT) technology	Yes (Pair of intelligent hemispheric camera with I95, I96, I97, I98 and I915 speed dome camera)

Video

Compression	H.264 (Baseline/ Main/ High profile), MJPEG
Maximum Frame Rate vs. Resolution	(Fisheye View) 18 fps at 4000 x 3000 30 fps at 2048 x 2048 30 fps at 1600 x 1200 30 fps at 1280 x 960 30 fps at 1024 x 1024 30 fps at 800 x 600 30 fps at 640 x 480 (Dewarped View) 10 fps at 4096 x 2160 (4K Ultra HD) 10 fps at 3840 x 2160 (4K Ultra HD) 30 fps at 1920 x 1080 30 fps at 1280 x 960 30 fps at 1280 x 720 30 fps at 800 x 600 30 fps at 640 x 480 (ePTZ View) 30 fps at 1920 x 1080 30 fps at 1600 x 1200 30 fps at 1280 x 960 30 fps at 1280 x 720 30 fps at 1024 x 1024 30 fps at 800 x 600 30 fps at 640 x 480 30 fps at 320 x 240
View Mode	Fisheye View Dewarped View 270-degree Corner View Multiple View ePTZ View
Bit Rate	128Kbps - 12Mbps
Bit Rate Mode	Constant, Variable
Multi-Streaming	Simultaneous triple streams based on configurations of video resolution, compression format, and frame rate
Digital Noise Reduction	2D + 3D DNR
Wide Dynamic Range	Extreme WDR (130 dB)
Image Orientation	Flip, Mirror
Image Enhancement	White Balance, Brightness, Contrast, Sharpness, Automatic gain control (AGC), Flickerless, Defogging
Privacy Mask	8 configurable regions
Text Overlay	Yes
Built-in Analytics	Object Based Motion Detection, Tampering Detection, Shock Detection, Digital Auto Tracking, Object Line Crossing Detection, Object Enter Area Detection, Missing Object Detection, Unattended Object Detection, Object Loitering Detection
Server-based Analytics	Object Line Counting, People Counting, Face Detection, Object Based Motion Detection, Tamper, Object Line Crossing Detection, Object Enter Area Detection, Missing Object Detection, Unattended Object Detection, Smoke Detection, Heat Map, Dwell Time, People Queue Detection, (Require PC-based or standalone IVS or ALPR Server. Contact ACTi support for recommendations on how to maximize analytical accuracy)

IVS performance	Certain algorithms may require more computing power, which may limit the number of algorithms that can be concurrently used in the camera. Please test the actual performance before using in a project.
-----------------	--

Audio

Audio Type	2-way, Built-in Microphone, Mic-in, Line-in, Line-out
Audio Compression	8 kHz, 16 bit encoding, Mono, PCM, G.711

Network

Network Protocol & Service	IPv4/v6, TCP, UDP, DHCP, PPPoE, HTTP, HTTPS, DNS, DDNS, NTP, RTP, RTSP, RTCP, SMTP, FTP, IGMP, ICMP, ARP, Bonjour, UPnP, QoS, SNMP, IEEE 802.1X
Ethernet Port	1 x RJ-45 connector
Security	IP address filtering, HTTPS encryption, Password protected user level, Anonymous login, IEEE 802.1X network access control, Standard IoT Security (anti-hacking, anti-malware)

Video Analytics

Analysis Source Type	Video
Metadata Accuracy	Standard

Event

Event Trigger	Video motion detection (10 included and excluded polygonal regions), External device through digital input, Sound detection, Intelligent event detection,
Event Response	Notify control center, Go to ePTZ preset point or preset tour, Change camera settings, Command other devices, E-mail notification with snapshots, Play the audio file, Push notification to mobile device, Save video to storage, Save video or snapshot to storage, Upload video to NVR server, Upload video or snapshot to FTP server, Activate external device through digital output

System

Watchdog	Support
----------	---------

Integration

Unified Solution	Fully compatible with ACTi software
Software Development Kit	Yes
GPS Position	Manual setting
Edge Recording	Support (integration with NVR by ONVIF Profile G or proprietary protocol)*
ONVIF Compliant	Yes, Profile G, Profile T, Profile Q, Profile M* (To be available through future firmware upgrade)
GB28181 Compliant	Yes
Web Browser	IE 11
Auto Firmware Upgrade	Yes

Interface

Audio Interface	1/1, 3.5mm Phone Jack, Built-in microphone
Digital Input/Output	1/1 (Terminal block)
Operating Button	Reset Button

General

Power Source	PoE Class 3 (IEEE802.3af), DC 12V
Power Consumption	7.17 W (PoE)
Weight	446g (0.983lb)
Dimensions	(Ø x H): 149.10mm x 43.00mm (5.9" x 1.7")
Mount Type	Surface, Gang Box, Flush, Pendant, Converter for NPT Standard Mounts, Tilted Mount, Wall Mount, Pole Mount, Corner Mount
Starting Temperature	-10°C ~ 50°C (14°F ~ 122°F)
Operating Temperature	-10°C ~ 50°C (14°F ~ 122°F)
Operating Humidity	10% - 85% RH, non-condensing
Approvals	CE, FCC, EAC, UL (for optional PoE injector and power adapter)
Real-time Clock (RTC)	Yes
Warranty	3 Year(s). For extended warranty offering, see http://www.acti.com/support/warranty

* Edge Recording function is integrated with NVR 3 Corporate / NVR 3 Business / INR / GNR series.

▶ Photo Indication

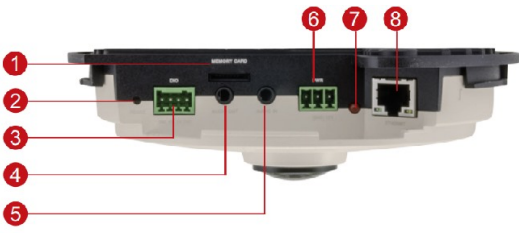

- 1 Memory Card Slot
- 2 Reset Button
- 3 Digital Input/Output
- 4 Audio Output
- 5 Audio Input
- 6 DC 12V Power Input
- 7 Power LED
- 8 Ethernet Port
- 9 Built-in Microphone



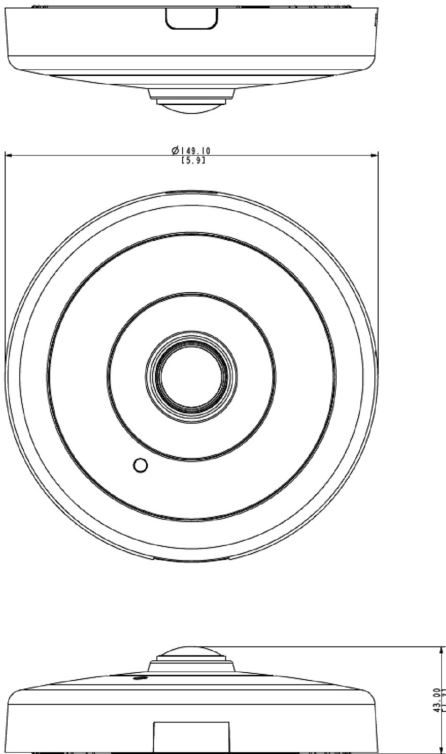













▶ Dimension Diagram



Unit: mm [inch]

▶ Related Products

Mounting Accessories - Camera Mount

PMAX-0102		Straight Tube
PMAX-0103		Straight Tube with Bracket
PMAX-0104		Extension Tube
PMAX-0130		Mount Kit (for A711, A713)
PMAX-0302		Gooseneck with Bracket
PMAX-0303		Gooseneck
PMAX-0305		Heavy Duty Wall Mount
PMAX-0313		Heavy Duty Wall Mount for Indoor Domes (for B5x, B6x, D6x, E6x, I5x)
PMAX-0320		Tilted Wall Mount for Indoor Hemispheric Cameras with IR LED
PMAX-0338		35-Degree Tilted Wall Mount for Fisheye and Hemispheric Cameras
PMAX-0402		Corner Mount
PMAX-0503		Pole Mount (for PMAx-0102, PMAx-0312, PMAx-0313, PMAx-0314, PMAx-0702, PMAx-1106, PMAx-1107), supports 5.25" to 8.5" Poles
PMAX-0702		Junction Box for PTZ and Dome Cameras
PMAX-0804		Gang Box Converter for Outdoor Domes, supports Two-Gang Boxes
PMAX-0808		Converter Ring, 1.5" NPT for Third-Party Mounting Accessories
PMAX-1011		Flush Mount Kit (for B511)

Note: Some mounting accessories may need additional accessories for installation. Please check www.acti.com/mountingselector for more information.

Power Supply Accessories - PoE Injector

PPOE-0107  High PoE Injector IEEE 802.3at compliant, AC 100~240V, with universal connectors (for A416, A418, B913, B923, B934, Q450, Q75, VMGB-60X, Z37, Z71, Z952)

Network & Storage Peripherals - Data Switch

PPSW-0102  PLANET FGSD-1011HP 8-Port 802.3at PoE Switch (PoE Budget 120W)

PPSW-0105  PLANET GS-4210-8P2C 8-Port Gigabit 802.3at Managed PoE Switch (PoE Budget 120W)

PPSW-1101  PLANET GS-4210-24PL4C 24-Port Gigabit 802.3at Managed PoE Switch (PoE Budget 440W)

PPSW-3100  PLANET FGSW-1816HPS 16-Port 802.3at PoE Switch (PoE Budget 220W)

Extenders - PoE Extender

PPEX-0100  Veracity OUTREACH Max Power over Ethernet (PoE) Extender

Extenders - PoE over Coaxial Extender Kit

PPOC-0100  Planet LRP-101C-KIT Power over Coax Adapter Kit

Audio Devices - Microphone

PMIC-0100  Active Microphone Omnidirectional for all Cameras with Line-in Audio

PMIC-0200  Passive Microphone Omnidirectional for all Cameras with Mic-in Audio using 3.5mm Phone Jack

Illuminators - IR LED Illuminator

PLED-0200  SPINLUX (SL-A2IRXX10-24CL) IR Illuminator 10° Angle with 120 m approx. range

PLED-0201  SPINLUX (SL-A2IRXX25-24CL) IR Illuminator 25° Angle with 50 m approx. range