

B916

2MP 20x Outdoor PTZ with WDR 145dB



- 2 Megapixel, 20x, PTZ
- Extreme WDR (145 dB)
- Color Min. Illumination 0.002 lux
- Frame Rate 60fps
- 360° endless
- Weatherproof (IP67), Vandal proof (IK10), NEMA 4X, UL Listed

► Specifications

Product Profile

Product Type	PTZ
Application Environment	Outdoor
Maximum Resolution	2MP
Image Sensor	Progressive Scan CMOS
Sensor Size	1/2.8 "
Effective Pixels	1944(H) X 1224(V) (2.38 MP)
Day / Night	Yes
Low Light Sensitivity	Extreme
Minimum Illumination	Color: 0.002 lux at F1.6 (30 IRE); B/W: 0.001 lux (IR LED on)
Mechanical IR Cut Filter	Yes
IR Sensitivity Range	700-1100nm
Color to B/W Switch	ISP based switch, configurable
Electronic Shutter	1/5-1/32000 second (manual mode); 1/5-1/32000 second (auto mode)
Horizontal Resolution (TV Lines)	1450 TVL
S/N Ratio	75 dB

Lens

Focal Length	Zoom, f4.7-94mm
Aperture	F1.6-F3.5
Zoom Ratio	20x optical zoom, 16x digital zoom
Zoom Speed	2.2 second (wide to tele)
Zoom Application	Camera Installation, Auto Zoom by Event, Manual Operation
Iris	DC iris
Focus	Auto focus
Lens Mount	Board mount
Horizontal Viewing Angle	62° - 2.8°
Vertical Viewing Angle	36.4° - 1.4°

PTZ

Scan Panning / Tilting Speed	0.16° - 32°/second, 0.16° - 16°/second
Manual Panning / Tilting Speed	0.16° - 54.4°/second, 0.16° - 27.2°/second
Preset Panning / Tilting Speed	0.16° - 720°/second, 0.16° - 360°/second
Panning Range	360° endless
Tilting Range	-20°~200°
PTZ Control	Remote manual control, Speed Control, Select box to PTZ, 256 preset points, 10 preset tours, Auto scan
Preset Accuracy (Panning/Tilting)	±0.265°/±0.149°
Absolute Position	Yes
Pan, Tilt or Zoom protocol	Visca, Pelco-D, Pelco-P, ACTi URL command

Video

Compression	H.264 (Baseline/ Main/ High profile), MJPEG
Maximum Frame Rate vs. Resolution	60 fps at 1920 x 1080 60 fps at 1280 x 720 30 fps at 640 x 480 30 fps at 320 x 240
High Frame Mode	Support
Bit Rate	128Kbps - 12Mbps
Bit Rate Mode	Constant, Variable
Multi-Streaming	Simultaneous triple streams based on configurations of video resolution, compression format, and frame rate
Digital Noise Reduction	2D + 3D DNR
Wide Dynamic Range	Extreme WDR (145 dB)
Image Enhancement	White Balance, Brightness, Contrast, Sharpness, Automatic gain control (AGC), Flickerless, Digital Image Stabilizer (DIS, EIS), Defogging
Privacy Mask	20 configurable 3D privacy masks
Text Overlay	Yes

On-Screen Graphics (Picture Overlay)	Yes
Built-in Analytics	Basic Face Detection, Object Based Motion Detection, Tampering Detection, Shock Detection, PTZ Auto Tracking, Object Line Crossing Detection, Object Enter Area Detection, Missing Object Detection, Unattended Object Detection, Object Loitering Detection
Server-based Analytics	Object Line Counting, People Counting, Face Detection, Object Based Motion Detection, Tamper, Object Line Crossing Detection, Object Enter Area Detection, Missing Object Detection, Unattended Object Detection, Smoke Detection, Heat Map, Dwell Time, Direction Detection, Automatic License Plate Recognition, People Queue Detection, (Require PC-based or standalone IVS or ALPR Server. Contact ACTi support for recommendations on how to maximize analytical accuracy)
IVS performance	Certain algorithms may require more computing power, which may limit the number of algorithms that can be concurrently used in the camera. Please test the actual performance before using in a project.

Audio

Audio Type	2-way, Mic-in, Line-in, Line-out
Audio Compression	8 kHz, 16 bit encoding, Mono, PCM, G.711

Network

Network Protocol & Service	IPv4, IPv6, TCP, UDP, DHCP, PPPoE, HTTP, HTTPS, DNS, DDNS, NTP, RTP, RTSP, RTCP, SRTP, LLDP, SMTP, FTP, IGMP, ICMP, ARP, Bonjour, UPnP, QoS, SNMP, IEEE 802.1X
Ethernet Port	1 x Ethernet (10/100 Base-T), RJ-45 pigtail connector
Security	IP address filtering, HTTPS encryption, SRTP encrypted video streaming, Password protected user level, Anonymous login, IEEE 802.1X network access control, Standard IoT Security (anti-hacking, anti-malware)

Video Analytics

Analysis Source Type	Video
Metadata Accuracy	Standard

Event

Event Trigger	Video motion detection (10 included and excluded polygonal regions), External device through digital input, Sound detection, Intelligent event detection, Video streams loss, System log buffer overrun, Remove system log, Logon events (Login Failure, Login Success, Block an Account)
Event Response	Notify control center, Go to PTZ preset point or preset tour, Change camera settings, Command other devices, E-mail notification with snapshots, Play the audio file, Push notification to mobile device, Save video to storage, Upload video to NVR server, Upload video or snapshot to FTP server, Activate external device through digital output

System

System Monitor	CPU loading, memory usage and network statistics via API
System Log	Support
Watchdog	Support

Integration

Unified Solution	Fully compatible with ACTi software
Software Development Kit	Yes

GPS Position	Manual setting
Edge Recording	Support (integration with NVR by ONVIF Profile G or proprietary protocol)**
ONVIF Compliant	Profile S, Profile G, Profile T, Profile Q, Profile M* (To be available through future firmware upgrade)
GB28181 Compliant	Yes
Web Browser	IE 11, Google Chrome, Microsoft Edge, Apple Safari
Auto Firmware Upgrade	Yes

Interface

Audio Interface	1/1, Cable with 3.5mm Phone Jack
Digital Input/Output	4/2
Operating Button	Reset Button

General

Power Source	AC 24V, High PoE 45W
Power Consumption	29.4 W (PoE, heater and fan on), 68 W (AC, heater and fan on)
Weight	2605g (5.743lb)
Environmental Casing	Weatherproof (IP67), Vandal proof (IK10), Built-in dehumidifier
Corrosion Protection	Optional for project request. Chassis corrosion resistance at the seashore approximately 10 years.
Bundled Accessories	High PoE injector (USA only) or Power Adapter (AC 24V for regions outside the USA)
Mount Type	Gang Box, Pendant, Converter for NPT Standard Mounts, Wall Mount, Pole Mount, Corner Mount
Fan	Yes
Heater	Yes
Dehumidifier	Yes
Starting Temperature	-52°C ~ 60°C (-61.6°F ~ 140°F) within 30 minutes at AC 24V, -40°C ~ 60°C (-40°F ~ 140°F) within 30 minutes at High PoE
Operating Temperature	-52°C ~ 60°C (-61.6°F ~ 140°F) for AC 24V, -40°C ~ 60°C (-40°F ~ 140°F) for High PoE
Approvals	Camera: CE Class B, Camera: FCC Class B, EAC, CB, UL Listed (UL 62368-1), IP67, IK10, NEMA 4X
Real-time Clock (RTC)	Yes
Warranty	3 Year(s) (1 year in continuous motion). For extended warranty offering, see http://www.acti.com/support/warranty

** Edge Recording function is integrated with NVR 3 Corporate / NVR 3 Business / INR / GNR series.

▶ Photo Indication

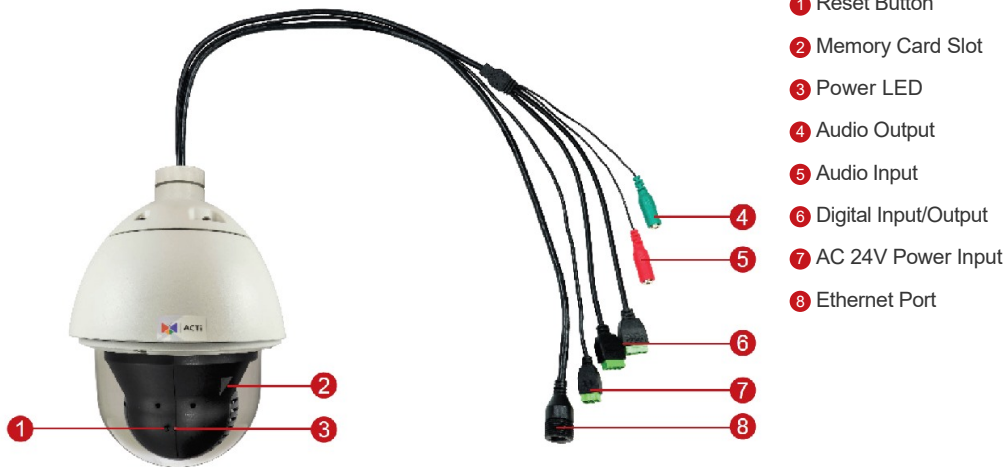



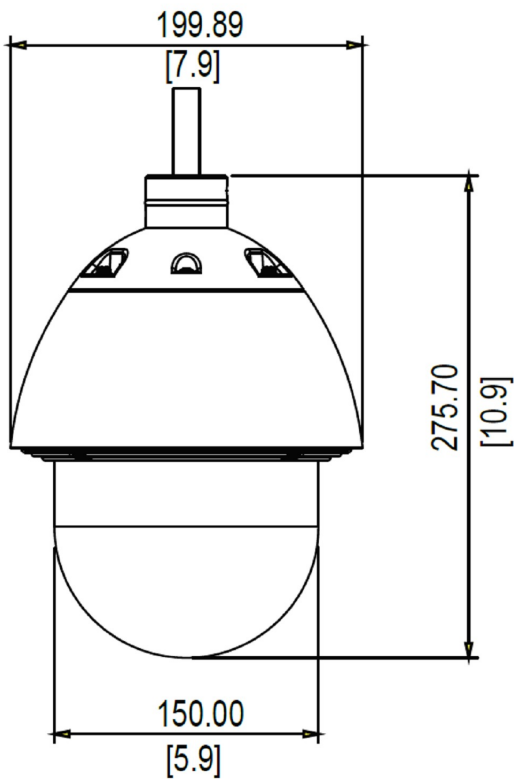









▶ Dimension Diagram



Unit: mm [inch]

▶ Related Products

Mounting Accessories - Camera Mount

PMAX-0102		Straight Tube
PMAX-0103		Straight Tube with Bracket
PMAX-0104		Extension Tube
PMAX-0302		Gooseneck with Bracket
PMAX-0303		Gooseneck
PMAX-0305		Heavy Duty Wall Mount
PMAX-0312		PTZ Wall Mount for Outdoor PTZ / Speed Dome (except KCM-8211 & TCM-6630)
PMAX-0402		Corner Mount
PMAX-0503		Pole Mount (for PMA-0102, PMA-0312, PMA-0313, PMA-0314, PMA-0702, PMA-1106, PMA-1107), supports 5.25" to 8.5" Poles
PMAX-0505		Pole Mount (for B4x, B41x, E44, E45, E46, E48, E44A, E45A, E46A, E41x, I4x, PMA-0312, PMA-0313, PMA-0314, PMA-0330), supports 2" to 3" Poles
PMAX-0702		Junction Box for PTZ and Dome Cameras
PMAX-0807		Gangbox Converter (for PMA-0102, PMA-0312, PMA-0313, PMA-0314, PMA-0321), supports Two-Gang Boxes
PMAX-0808		Converter Ring, 1.5" NPT for Third-Party Mounting Accessories

Note: Some mounting accessories may need additional accessories for installation. Please check www.acti.com/mountingselector for more information.



Dome Covers - Transparent Dome Cover

R701-30001		Vandal Proof Transparent Dome Cover (for I93~I97, I910, B916, B917)
------------	---	---





Power Supply Accessories - Power Adapter

PPBX-0008		Power Adapter AC 100~240V, with universal connectors for PLED-0203~PLED-0205
-----------	---	--

Power Supply Accessories - PoE Injector

PPOE-0102		High PoE Injector IEEE 802.3at compliant, AC 100~240V, with universal connectors (for I93~I910, KCM-8211)
PPOE-0103		High PoE Injector, Single-port, 60W Gigabit Midspan, 4-Pairs, 802.3at Compliant, AC 100~240V, with universal connectors (for, I93~I910, I915, B915~B917, B922, B928, B945, B949, A950, A951)
PPOE-0104		High PoE Injector, Single-port, 10/100/1000Mbps 60W, 4-Pairs, 802.3at Compliant, AC 100~240V, with universal connectors (for, I93~I910, I915, B915~B917, B922, B928, B945, B949, A950, A951)

Network & Storage Peripherals - Data Switch

PPSW-0102		PLANET FGSD-1011HP 8-Port 802.3at PoE Switch (PoE Budget 120W)
PPSW-0105		PLANET GS-4210-8P2C 8-Port Gigabit 802.3at Managed PoE Switch (PoE Budget 120W)
PPSW-1101		PLANET GS-4210-24PL4C 24-Port Gigabit 802.3at Managed PoE Switch (PoE Budget 440W)
PPSW-3100		PLANET FGSW-1816HPS 16-Port 802.3at PoE Switch (PoE Budget 220W)



Extenders - PoE Extender

PPEX-0100		Veracity OUTREACH Max Power over Ethernet (PoE) Extender
-----------	---	--

Extenders - PoE over Coaxial Extender Kit

PPOC-0100		Planet LRP-101C-KIT Power over Coax Adapter Kit
-----------	---	---

Audio Devices - Microphone

PMIC-0100		Active Microphone Omnidirectional for all Cameras with Line-in Audio
PMIC-0200		Passive Microphone Omnidirectional for all Cameras with Mic-in Audio using 3.5mm Phone Jack

Illuminators - IR LED Illuminator

PLED-0200		SPINLUX (SL-A2IRXX10-24CL) IR Illuminator 10° Angle with 120 m approx. range
PLED-0201		SPINLUX (SL-A2IRXX25-24CL) IR Illuminator 25° Angle with 50 m approx. range