

# Q12

## 2MP with WDR 75dB



- 2 Megapixel, f2.55mm,
- Vibration proof (EN50155)

## ► Specifications

### Product Profile

Product Type	Covert
Application Environment	Indoor
Maximum Resolution	2MP
Image Sensor	Progressive Scan CMOS
Sensor Size	1/2.8 "
Effective Pixels	1944(H) X 1224(V) (2.38 MP)
Day / Night	No
Low Light Sensitivity	Superior
Minimum Illumination	Color: 0.1 lux at F2.2 (30 IRE, 2400 K)
Mechanical IR Cut Filter	No
Horizontal Resolution (TV Lines)	1100 TVL
S/N Ratio	52 dB

### Lens

Focal Length	Fixed focal, f2.55mm
Aperture	F2.2

Iris	Fixed iris
Focus	Fixed focus
Lens Mount	RJ12 connector up to 12m from main unit
Horizontal Viewing Angle	110.3°
Vertical Viewing Angle	61.3°

## Video

Compression	H.264 (Baseline/ Main/ High profile), MJPEG
Maximum Frame Rate vs. Resolution	30 fps at 1920 x 1080 30 fps at 1280 x 720 30 fps at 800 x 600 30 fps at 640 x 480 15 fps at 320 x 240
Bit Rate	28Kbps - 6Mbps
Bit Rate Mode	Constant, Variable
Multi-Streaming	Simultaneous dual streams based on two configurations
Digital Noise Reduction	2D + 3D DNR
Wide Dynamic Range	Basic WDR (75 dB)
Privacy Mask	4 configurable regions
On-Screen Graphics (Picture Overlay)	Yes
Server-based Analytics	Object Line Counting, People Counting, Face Detection, Object Based Motion Detection, Tamper, Object Line Crossing Detection, Object Enter Area Detection, Missing Object Detection, Unattended Object Detection, Smoke Detection, Heat Map, Dwell Time, People Queue Detection, (Require PC-based or standalone IVS or ALPR Server. Contact ACTi support for recommendations on how to maximize analytical accuracy)

## Audio

Audio Type	2-way, Mic-in, Line-in, Line-out
Audio Compression	8 kHz, 16 bit encoding, Mono, PCM, G.711

## Network

Network Protocol & Service	IPv4/v6, TCP, UDP, DHCP, PPPoE, HTTP, HTTPS, DNS, DDNS, NTP, RTP, RTSP, RTCP, SMTP, FTP, IGMP, ICMP, ARP, Bonjour, UPnP, QoS, SNMP, IEEE 802.1X
Ethernet Port	1 x RJ-45 connector
Security	IP address filtering, HTTPS encryption, Password protected user level, Anonymous login, IEEE 802.1X network access control, Standard IoT Security (anti-hacking, anti-malware)

## Event

Event Trigger	Video motion detection (3 regions), External device through digital input, Sound detection,
Event Response	Notify control center, Change camera settings, Command other devices, E-mail notification with snapshots, Play the audio file, Push notification to mobile device, Save video to storage, Upload video or snapshot to FTP server, Upload video to NVR server, Activate external device through digital output

## System

System Monitor	CPU loading, memory usage and network statistics via API
----------------	--

Watchdog

Support

**Integration**

Unified Solution	Fully compatible with ACTi software
GPS Position	Manual setting
ONVIF Compliant	Yes, Profile S, Profile G, Profile T, Profile Q
GB28181 Compliant	Yes
Auto Firmware Upgrade	Yes

**Interface**

Serial Port	1 x RS-232
Digital Input/Output	1/1
Operating Button	Reset Button

**General**

Power Source	DC 12V, PoE Class 2 (IEEE802.3af)
Power Consumption	4.32 W (PoE)
Weight	621g (1.369lb)
Dimensions	Main Unit (W x H x D): 75mm x 100.33mm x 30mm (3.0" x 4.0" x 1.2") Lens Unit (Ø x L): 26mm x 61.94mm (1.0" x 2.4")
Environmental Casing	Vibration proof (EN50155)
Mount Type	Bracket, Flush, Tilttable Flush Mount, Corner Mount
Starting Temperature	-20°C ~ 50°C (-4°F ~ 122°F)
Operating Temperature	-30°C ~ 60°C (-22°F ~ 140°F)
Approvals	CE, FCC, EAC, EN50121-3-2, EN50155, UL (for optional PoE injector and power adapter)
Real-time Clock (RTC)	Yes
Warranty	3 Year(s). For extended warranty offering, see <a href="http://www.acti.com/support/warranty">http://www.acti.com/support/warranty</a>

► Photo Indication



- 1 LED Indicators
- 2 Memory Card Slot
- 3 Digital Input/Output
- 4 Camera Input
- 5 Audio-In/Audio-Out
- 6 Ethernet Port
- 7 Serial Port
- 8 DC 12V Power Input
- 9 Reset Button

► Dimension Diagram

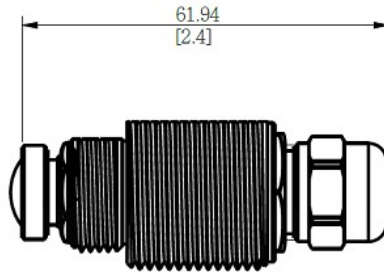
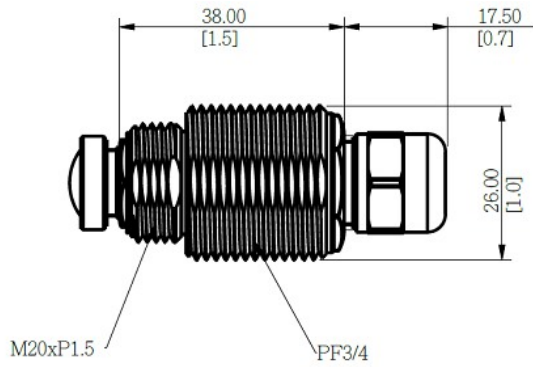

Unit: mm [inch]

## ▶ Related Products

### Mounting Accessories - Camera Mount

PMAX-0403  Corner Mount for Covert and Pinhole Covert Cameras

PMAX-1108  Bracket for all Covert Cameras (except L-Shape Pinhole)

R707-A0007  Bundled Mounting Rail Kit for Covert Camera

**Note:** Some mounting accessories may need additional accessories for installation. Please check [www.acti.com/mountingselector](http://www.acti.com/mountingselector) for more information.

### Power Supply Accessories - Power Adapter

PPBX-0011  Power Adapter AC 100~240V, with universal connectors for all DC12V powered devices

### Network & Storage Peripherals - Data Switch

PPSW-0102  PLANET FGSD-1011HP 8-Port 802.3at PoE Switch (PoE Budget 120W)

PPSW-0105  PLANET GS-4210-8P2C 8-Port Gigabit 802.3at Managed PoE Switch (PoE Budget 120W)

PPSW-1101  PLANET GS-4210-24PL4C 24-Port Gigabit 802.3at Managed PoE Switch (PoE Budget 440W)

PPSW-3100  PLANET FGSW-1816HPS 16-Port 802.3at PoE Switch (PoE Budget 220W)

### Extenders - PoE Extender

PPEX-0100  Veracity OUTREACH Max Power over Ethernet (PoE) Extender

### Extenders - PoE over Coaxial Extender Kit

PPOC-0100  Planet LRP-101C-KIT Power over Coax Adapter Kit

### Audio Devices - Microphone

PMIC-0100  Active Microphone Omnidirectional for all Cameras with Line-in Audio

PMIC-0201  Passive Microphone Omnidirectional for all Cameras with Mic-In Audio using Cable Wire or Terminal Connector, 2m cable