

# E816

10MP 4.3x with IR LED 30m, WDR 70dB



- 10 Megapixel, 4.3x,
- IR LED 30m
- DORI (62-266 / 25-107.3 / 12.4-53.2 / 6.2-26.6m)
- Weatherproof (IP67), Vandal proof (IK10), NEMA 4X

## ► Specifications

### Product Profile

Product Type	Zoom Dome
Application Environment	Outdoor
Maximum Resolution	10MP
Image Sensor	Progressive Scan CMOS
Sensor Size	1/2.3 "
Effective Pixels	3856(H) X 2764(V) (10.66 MP)
Day / Night	Yes
Low Light Sensitivity	Standard
Minimum Illumination	Color: 0.1 lux at F1.4 (30 IRE, 2400 K); B/W: 0 lux at F1.4 (IR LED on)
Mechanical IR Cut Filter	Yes
IR Sensitivity Range	700-1100nm
IR LED	Adaptive IR LED x 10 (850 nm)
IR Working Distance	30m
Color to B/W Switch	ISP based switch, configurable
Electronic Shutter	1/5-1/2000 second (manual mode); 1/5-1/10000 second (auto mode)

Horizontal Resolution (TV Lines)	1450 TVL
S/N Ratio	75 dB

## Lens

Focal Length	Zoom, f3.1-13.3mm
Aperture	F1.4-F4.0
Zoom Ratio	4.3x optical zoom
Zoom Speed	3 second (wide to tele)
Zoom Application	Camera Installation
Iris	P-Iris
Focus	Auto focus
Lens Mount	Board mount
Horizontal Viewing Angle	90.6° - 34.3°
Vertical Viewing Angle	68.7° - 26.4°
Viewing Angle Adjustment	Pan: 0°-350°, Tilt: 5°-175°, Rotation: 0°-350°

## PTZ

Absolute Position	Yes
Pan, Tilt or Zoom protocol	Visca, Pelco-D, Pelco-P, ACTi URL command

## Video

Compression	H.264 (Baseline/ Main/ High profile), MJPEG
Maximum Frame Rate vs. Resolution	7 fps at 3648 x 2736 7 fps at 3648 x 2160 7 fps at 2592 x 1944 7 fps at 2048 x 1536 30 fps at 1920 x 1080 30 fps at 1280 x 720 30 fps at 800 x 600 30 fps at 640 x 480 15 fps at 320 x 240
Bit Rate	28Kbps - 6Mbps
Bit Rate Mode	Constant, Variable
Multi-Streaming	Simultaneous dual streams based on two configurations
Digital Noise Reduction	2D + 3D DNR
Wide Dynamic Range	Basic WDR (70 dB)
Image Orientation	Flip, Mirror
Image Enhancement	White Balance, Brightness, Contrast, Sharpness, Automatic gain control (AGC), Flickerless
Privacy Mask	4 configurable regions
On-Screen Graphics (Picture Overlay)	Yes
Server-based Analytics	Object Line Counting, People Counting, Face Detection, Object Based Motion Detection, Tamper, Object Line Crossing Detection, Object Enter Area Detection, Missing Object Detection, Unattended Object Detection, Smoke Detection, Heat Map, Dwell Time, Direction Detection, Automatic License Plate Recognition, People Queue Detection, (Require PC-based or standalone IVS or ALPR Server. Contact ACTi support for recommendations on how to maximize analytical accuracy)

**Audio**

Audio Type	2-way, Line-in, Line-out
Audio Compression	8 kHz, 16 bit encoding, Mono, PCM, G.711

**Network**

Network Protocol & Service	IPv4/v6, TCP, UDP, DHCP, PPPoE, HTTP, HTTPS, DNS, DDNS, NTP, RTP, RTSP, RTCP, SMTP, FTP, IGMP, ICMP, ARP, Bonjour, UPnP, QoS, SNMP, IEEE 802.1X
Ethernet Port	1 x RJ-45 connector
Security	IP address filtering, HTTPS encryption, Password protected user level, Anonymous login, IEEE 802.1X network access control, Standard IoT Security (anti-hacking, anti-malware)

**Detection Range**

Observation Range	Detection: 62m-266m Observation: 25m-107.3m Recognition: 12.4m-53.2m Identification: 6.2m-26.6m
-------------------	---

**Event**

Event Trigger	Video motion detection (3 regions), External device through digital input, Sound detection, Video streams loss, System log buffer overrun, Remove system log, Logon events (Login Failure, Login Success, Block an Account)
Event Response	Notify control center, Change camera settings, Command other devices, E-mail notification with snapshots, Play the audio file, Push notification to mobile device, Save video to storage, Upload video or snapshot to FTP server, Upload video to NVR server, Activate external device through digital output

**System**

System Monitor	CPU loading, memory usage and network statistics via API
System Log	Support
Watchdog	Support

**Integration**

Unified Solution	Fully compatible with ACTi software
Software Development Kit	Yes
GPS Position	Manual setting
Edge Recording	Support (integration with NVR by ONVIF Profile G or proprietary protocol)*
ONVIF Compliant	Yes, Profile S, Profile G, Profile T, Profile Q
GB28181 Compliant	Yes
Auto Firmware Upgrade	Yes

**Interface**

Audio Interface	Terminal block
Digital Input/Output	2/2
Operating Button	Reset Button

**General**

Power Source	PoE Class 3 (IEEE802.3af)
Power Consumption	7.28 W (PoE)

Weight	1404g (3.095lb)
Dimensions	(Ø x H): 152.8mm x 131mm (6" x 5.2")
Environmental Casing	Weatherproof (IP67), Vandal proof (IK10)
Corrosion Protection	Optional for project request. Chassis corrosion resistance at the seashore approximately 10 years.
Mount Type	Surface, Gang Box, Flush, Pendant, Converter for NPT Standard Mounts, Wall Mount, Pole Mount, Corner Mount
Heater	Yes
Starting Temperature	-20°C ~ 50°C (-4°F ~ 122°F) within 30 minutes
Operating Temperature	-30°C ~ 50°C (-22°F ~ 122°F)
Operating Humidity	10% - 85% RH, non-condensing
Approvals	CE Class B, FCC Class B, EAC, IP67, IK10, NEMA 4X, UL (for optional PoE injector)
Real-time Clock (RTC)	Yes
Warranty	3 Year(s). For extended warranty offering, see <a href="http://www.acti.com/support/warranty">http://www.acti.com/support/warranty</a>

\* Edge Recording function is integrated with NVR 3 Corporate / NVR 3 Business / INR / GNR series.

► Photo Indication

- ① Ethernet Port
- ② Memory Card Slot
- ③ Digital Input / Output
- ④ Audio Input / Output
- ⑤ Reset Button





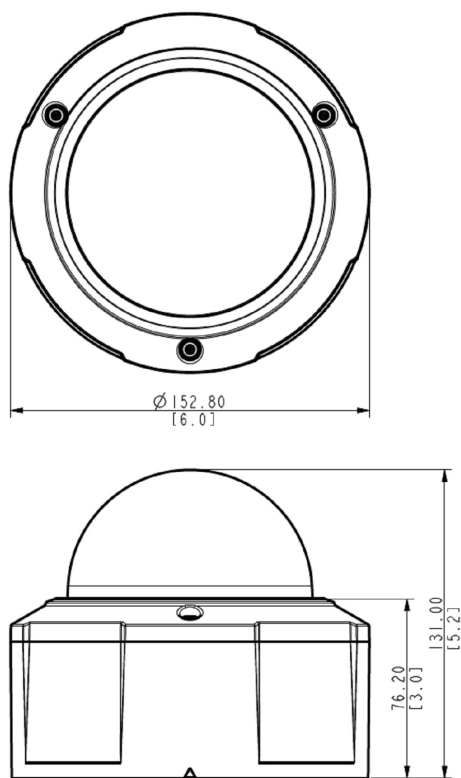













► Dimension Diagram



Unit: mm [inch]

## ► Related Products

### Mounting Accessories - Camera Mount





PMAX-0102		Straight Tube
PMAX-0103		Straight Tube with Bracket
PMAX-0104		Extension Tube
PMAX-0130		Mount Kit (for A711, A713)
PMAX-0302		Gooseneck with Bracket
PMAX-0303		Gooseneck
PMAX-0305		Heavy Duty Wall Mount
PMAX-0402		Corner Mount
PMAX-0503		Pole Mount (for PMA-0102, PMA-0312, PMA-0313, PMA-0314, PMA-0702, PMA-1106, PMA-1107), supports 5.25" to 8.5" Poles
PMAX-0505		Pole Mount (for B4x, B41x, E44, E45, E46, E48, E44A, E45A, E46A, E41x, I4x, PMA-0312, PMA-0313, PMA-0314, PMA-0330), supports 2" to 3" Poles
PMAX-0702		Junction Box for PTZ and Dome Cameras
PMAX-0804		Gang Box Converter for Outdoor Domes, supports Two-Gang Boxes
PMAX-0807		Gangbox Converter (for PMA-0102, PMA-0312, PMA-0313, PMA-0314, PMA-0321), supports Two-Gang Boxes
PMAX-0808		Converter Ring, 1.5" NPT for Third-Party Mounting Accessories
PMAX-1015		Flush Mount Kit (for B71, E89, E815~E817, E822)
PMAX-1501		Cable Gland for Outdoor Domes (except Hemispheric Domes)

**Note:** Some mounting accessories may need additional accessories for installation. Please check [www.acti.com/mountingselector](http://www.acti.com/mountingselector) for more information.

### Dome Covers - Transparent Dome Cover

R701-70007		Transparent Dome Cover Only (for B71, B9xA, B910, B914, E610, E616, E617, E618, E621, E89, E815, E816, E817)
------------	---	--

## Network & Storage Peripherals - Data Switch

PPSW-0102		PLANET FGSD-1011HP 8-Port 802.3at PoE Switch (PoE Budget 120W)
PPSW-0105		PLANET GS-4210-8P2C 8-Port Gigabit 802.3at Managed PoE Switch (PoE Budget 120W)
PPSW-1101		PLANET GS-4210-24PL4C 24-Port Gigabit 802.3at Managed PoE Switch (PoE Budget 440W)
PPSW-3100		PLANET FGSW-1816HPS 16-Port 802.3at PoE Switch (PoE Budget 220W)

## Extenders - PoE Extender

PPEX-0100		Veracity OUTREACH Max Power over Ethernet (PoE) Extender
-----------	---	--

## Extenders - PoE over Coaxial Extender Kit

PPOC-0100		Planet LRP-101C-KIT Power over Coax Adapter Kit
-----------	---	---

## Audio Devices - Microphone

PMIC-0100		Active Microphone Omnidirectional for all Cameras with Line-in Audio
-----------	---	--

## Illuminators - IR LED Illuminator

PLED-0200		SPINLUX (SL-A2IRXX10-24CL) IR Illuminator 10° Angle with 120 m approx. range
PLED-0201		SPINLUX (SL-A2IRXX25-24CL) IR Illuminator 25° Angle with 50 m approx. range

## Other Accessories - Camera Part

R707-90003		DIO / AIO connector for I73
------------	---	-----------------------------

## Other Accessories - Accessory Part

R707-70001		Conduit Gland for Dome Cameras
------------	---	--------------------------------